

CATALOG #	TYPE	
JOB NAME	WATTAGE	VOLTAGE

Lighting for Patient Spaces

Strait Secure RGBW Linear Slot

2.5" Recessed • Ligature Resistant • IK10-Rated
LM-80 Qualified • LM-79 Certified

Specifications

Luminaire Features

- Vandal- and ligature-resistant linear slot light
- Shallow extruded aluminum housing with vandal- and ligature-resistant frame
- White finish standard, or see options below
- Add patient-centric, behavioral health safe color-changing to spaces
- For use in behavioral health, transportation, education, and anywhere else a secure, color-changing fixture is needed

LED Driver - INTERNAL

- Indoor/Outdoor: -30°C to 60°C (-22°F to 140°F)
- 0-10V 1.0% dimming standard
- 120-277 volt

Vandal-Resistant Trim/Lens Assembly

- Ligature resistant smooth single-piece aluminum frame with 0.22" polycarbonate lens
- Discreet tamperproof screws placed along edge of frame to fixture housing; tamperproof tool included and can also be purchased separately
- Anti-pixellation optical film included above polycarbonate lens

Installation

- Securely mounts to hard ceiling for use in behavioral health environments
- Mount with #6 sheet rock fasteners, supplied by others
- Indoor/outdoor in ceilings up to 1 1/8" thick
- Minimum spacing between fixtures in 4.5" edge to edge in any direction

VRL-02CCM

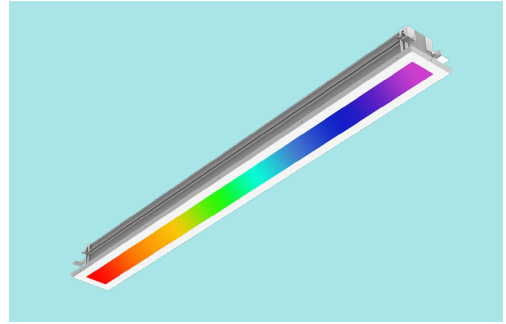

Color & Controls

- Quad chip RGBW LEDs provide rich color palette for full spectrum expression
- DMX control per fixture resolution; minimum 4 feet of Strait Secure Slot control
- Optional DMX control via Kirlin DMX wall panel **VND-DMXWP**
- Wall panel ships preloaded with standard scene configuration and presets - consult factory for custom programs

UL, C-UL (Canada) Listings

- Damp, dry locations, covered ceilings
- Type IC; approved for direct contact with insulation

Five Year Limited Warranty

- Complete standard fixture

 Made in the USA	 RGBW	 IK10 Impact Resistant	 Vandal Resistant	 BioGard™	 IP66 See Option -I66	 UL Listed Damp, Dry
--	---	--	---	---	--	---

Options and Ordering Configuration

(Example: VRL-02CCM-4FT-DD-RGB4-DMX)

Must Specify					Optional	
Model	Length	Beam	Output	Controls	Trim Options	Other Options
VRL-02CCM	-2FT † -4FT -6FT	-DD: Direct distribution	-RGB4: RGB + 4000°K, 80+ CRI	-DMX	(Blank): IK10-rated white trim with polycarbonate lens Trim Finishes -35T: Silver enamel -38T: Black enamel -BG: BioGard anti-microbial white -94: Custom color; consult factory Other Trim/Lens Features -I66: IP66 rated trim and lens; Meets ASTM E283 restricted airflow of 2CFM; Natatorium rated	(Blank): None -99: Special modification; consult factory -RD: Remote mounted Kirlin LED driver instead, sold separately

† -RD Remote driver required for -2FT run; minimum of 4 feet per room; consult factory for details

Dimensions (4 ft length shown)

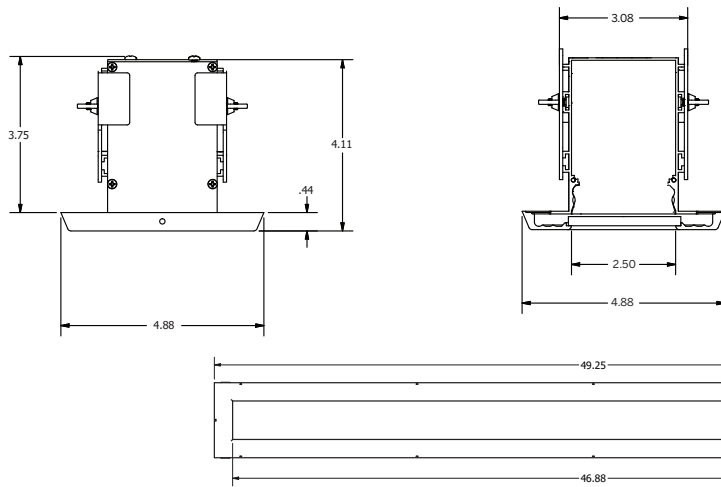

Length of Housing

A = Length of Housing (inches)	
-2FT	25 1/4"
-4FT	49 1/4"
-6FT	73 1/4"

Minimum spacing between fixtures in 4.5" edge to edge in any direction

Photometry - Installed Complete Fixture

Photometry from L.L.I., Allentown, PA

LM-79 IESNA Certified Photometry from Independent Lab

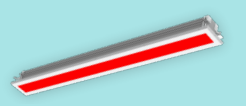

-2FT (Red LED)

Lumens: 189.5
Lumens/ft: 94.75
Wattage: 5.90
LPW: 32.1
Beam: 72.6°
LLI Test: 1792-07

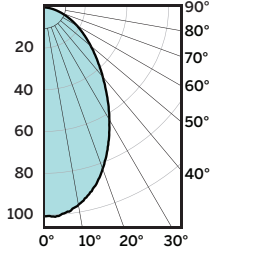

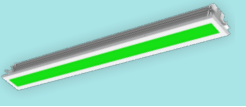

-2FT (Green LED)

Lumens: 446.0
Lumens/ft: 223
Wattage: 6.93
LPW: 64.4
Beam: 75.8°
LLI Test: 1792-08

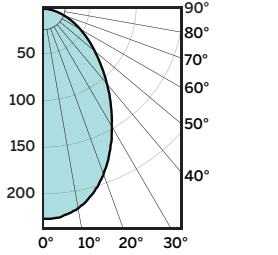

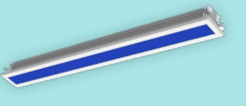

-2FT (Blue LED)

Lumens: 134.0
Lumens/ft: 67
Wattage: 7.51
LPW: 17.8
Beam: 75.4°
LLI Test: 1792-09

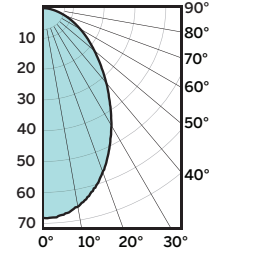

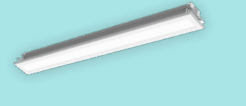

-2FT (White LED)

Lumens: 401.1
Lumens/ft: 200.55
Wattage: 7.68
LPW: 52.2
Beam: 73.4°
LLI Test: 1792-10

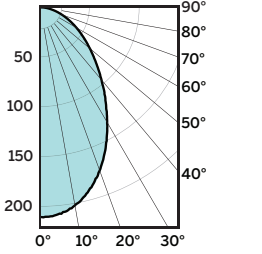

LIMITED WARRANTY: CATALOGED KIRLIN FIXTURES ARE WARRANTED FREE OF DEFECTS IN WORKMANSHIP OR MATERIAL FOR FIVE YEARS FROM DATE OF PURCHASE. INSTALLATION, E.G., IN NORMAL USE. Manufacturer at the option will replace or repair such fixture or refund the purchase price on presentation of proof of purchase and defective fixture at the office of manufacturer within the years of original shipment. Liability of manufacturer shall not be liable for any other damages, direct or indirect, sustained or suffered by purchaser or any person. This warranty is applied to the buyer in place of all other warranties, expressed or implied. Seller does not warrant as to merchantability or fitness for a particular use, nor will any oral statement constitute a warranty or amend this specific warranty. Abnormal use, abuse of the fixture, improper installation, or repair or modification of the fixture without prior written authorization from the manufacturer will render the warranty void.

PATENT SPACES
DECEMBER 2023