



Submittal Package/Purchasing Guide Symphony 0-10V System



Symphony 0-10V Remote Driver Cabinet2



Symphony 0-10V Remote Driver Modules3-5

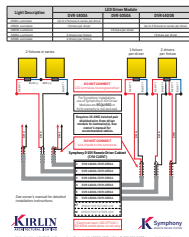

Symphony 0-10V Remote Driver Wiring Example6



CATALOG #	TYPE	
JOB NAME	WATTAGE	VOLTAGE

Symphony 0-10V Remote Driver Cabinet

SYM-CABNT

SYM-CABNT: Driver Cabinet

- 24" x 18" x 4.5" carbon steel enclosure supports up to 8 Remote Driver Modules (sold separately, see pages 3-4).
- Wall mounted enclosure fabricated from 14 gauge steel. Includes flat, removable cover fastened with plated steel screws. Cover design permits easy removal without extracting cover screws. Mounting holes on back of cabinet. Removable knockouts on all four sides.
- Certifications and Compliance: NEMA 1 rating, CSA, UL Listed.



Specifications

Dimensions	24" (h) x 18" (w) x 4.5" (d)
Weight	28 lb
Color	Black
Construction	Spot Welded
Cover Type	Screw Cover
Knockouts	Trade Sizes: 1/2"; 3/4"; 1" and 1-1/4"
Listings	UL, CSA
Material	Carbon Steel
Mounting Method	Embossed Mounting Holes
Mounting Type	Wall Mount
NEMA Rating	NEMA 1

Dimensions

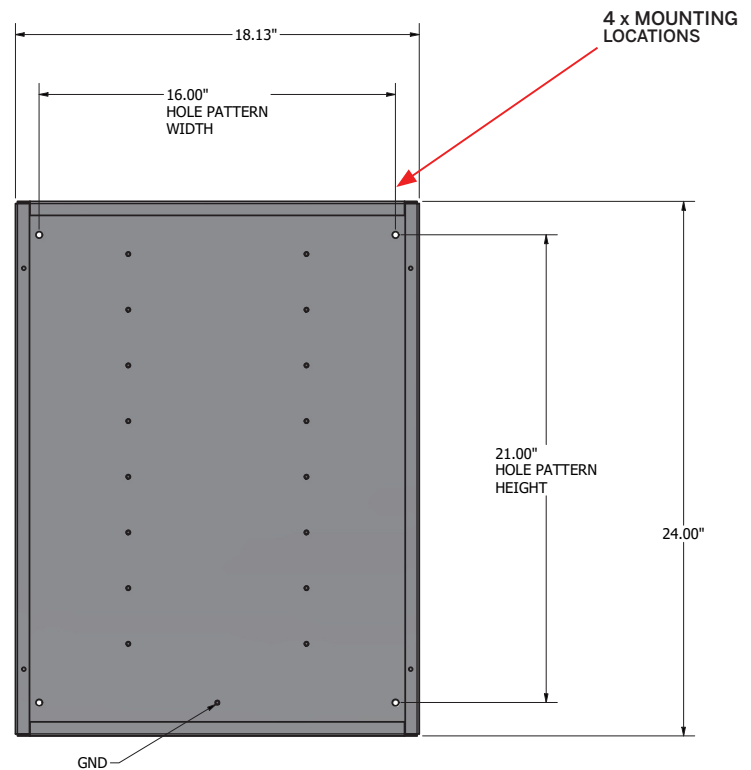
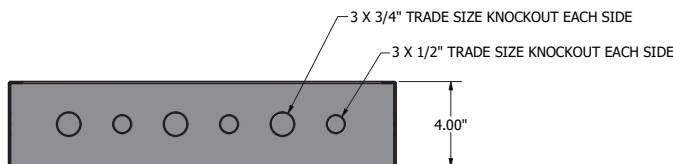

CATALOG #	TYPE	
JOB NAME	WATTAGE	VOLTAGE

Symphony 0-10V Remote Driver Modules

DVR-1400A/DVR-1050A/
DVR-1400B

Fully Digital Controlled Power Source for LED Luminaires

DVR-1400A: Driver Module

One module provides power and dimming control for:

- Up to two (2) 1500L Luminaires
- One (1) 2500L Luminaire
- 1/2 of a 5000L Luminaire (use 2 modules)
- 1/2 of a 6500L Luminaire (use 2 modules)

Order Number: DVR-1400A

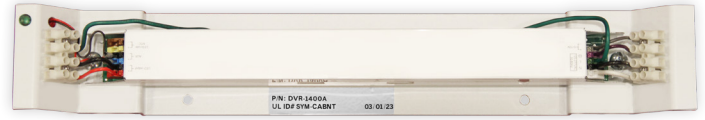

DVR-1050A: Driver Module

One module provides power and dimming control for:

- One (1) 4000L Luminaire

Order Number: DVR-1050A

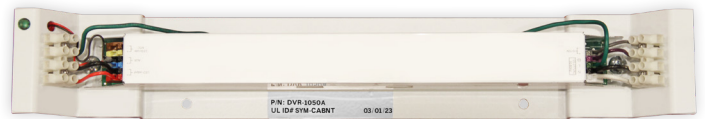

Must be used with Symphony 0-10V Driver Cabinet (SYM-CABNT).

Specifications

DVR-1400A & DVR-1050A

Input Electrical Specifications (Per Installed DVR Module)

Nominal input voltage range AC	120 - 277V
Absolute input voltage range AC	108 - 306V
Input frequency range	50 - 60Hz
Maximum wattage	50W
Efficiency at full load	85%
Power factor at full load	> 0.95
THD at full load	< 20%
Maximum inrush current	< 200mA ² s @ 120V / 60Hz < 200mA ² s @ 277V / 60Hz
Surge protection	2kV differential mode (DM) 2kV common mode (CM)
Maximum standby power	0.5W

Environmental Conditions

Operating ambient temperature (Ta) Range	
Module	-20°C to +50°C
Acoustic noise - steady state	< 24dBa (Class A)
All components	Dry location only

Dimming Control

Control protocol	0-10V
Dimming range	100% - 0.1%, off
Dimming curve	Linear

Remote Mounting Distance

Max. distance	250 feet
---------------	----------

Symphony 0-10V Remote Driver Modules

DVR-1400B

Fully Digital Controlled Power Source for LED Luminaires

DVR-1400B: Driver Module

One module provides power and dimming control for:

- Up to two (2) 2500L Luminaires
- One (1) 5000L Luminaire

Order Number: DVR-1400B

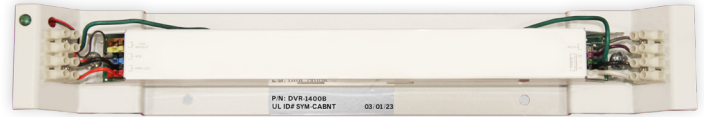

Must be used with Symphony 0-10V Driver Cabinet (SYM-CABNT).

Specifications

DVR-1400B

Input Electrical Specifications (Per Installed DVR Module)

Nominal input voltage range AC	120 - 277V
Absolute input voltage range AC	108 - 306V
Input frequency range	50 - 60Hz
Maximum wattage	75W
Efficiency at full load	85%
Power factor at full load	> 0.95
THD at full load	< 20%
Maximum inrush current	< 200mA ² s @ 120V / 60Hz < 200mA ² s @ 277V / 60Hz
Surge protection	2kV differential mode (DM) 2kV common mode (CM)
Maximum standby power	0.5W

Environmental Conditions

Operating ambient temperature (Ta) Range	
Module	-20°C to +50°C
Acoustic noise - steady state	< 24dBa (Class A)
All components	Dry location only

Dimming Control

Control protocol	0-10V
Dimming range	100% - 0.1%, off
Dimming curve	Linear

Remote Mounting Distance

Max. distance	250 feet
---------------	----------

Output Connections

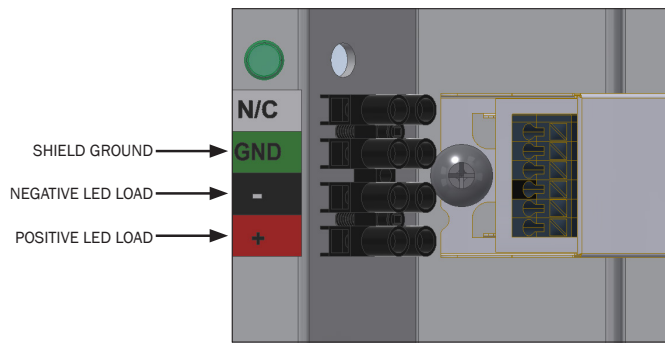

Input Connections

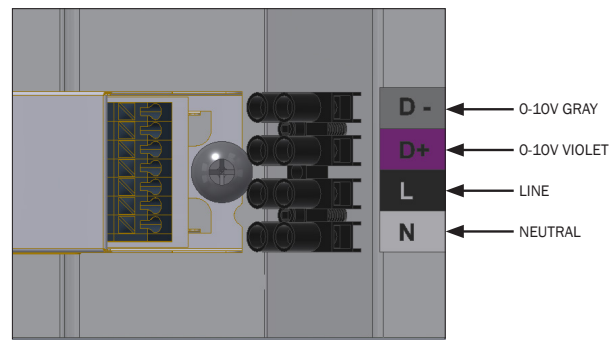

Input to modules can be separate or connected together (jumpers provided).

Standards & Compliance (Per Installed DVR Module)

UL Listed, Class P, Class 2	UL 1310 UL 8750	This low voltage luminaire system complies with UL 2108
Conducted emissions	FCC title 47 CFR part 15 class B	
Radiated emissions	FCC title 47 CFR part 15 class B	
Electrostatic discharge	EN 61000-4-2	
0-10V	IES/EN 60929 annex E NOTE: From 0.6V to 10V drivers comply with IEC/EN 60929 annex E. Below 0.6V LED drivers comply with ABL 0-10V. Design Spec v1.2 enabling standby mode.	
Surge protection	ANSI 62.41 1991 category B1: 2.5kV DM, 2.5kV CM @ 30 Ohm 0-10V input 0.5kV DM, 1kV CM surge	
Restriction of hazardous substances	RoHS3 (Directives 2011/65/EU-2015/863/EU)	

Compatible Dimmers and Controls

COMPATIBLE DIMMING CONTROL SYSTEMS	
Manufacturer	Type
Lutron Electronics	GraphicEye - GRX-TV1 w GRX3503, Linear Energy Savr Node - QSN-4T16-S, TVM2 Module
Crestron	GLX-DIMFLV8, GLXP-DIMFLV8, GLPAC-DIMFLV4-*, GLPAC-DIMFLV8-*, GLPP-DIMFLVEX-PM, GLPP-1DIMFLV2EX-PM, GLPP-1DIMFLV3EX-PM, DIN-AO8, DIN-4DIMFLV4, CLS-EXP-DIMFLV, CLCI-1DIMFLV2EX
ABB	SD/S 2.16.1

Note: Some dimmers may cause reduced stability at the lowest dim level setting; this is normal and may be resolved by increasing the lowest dim level setting if your selected dimmer allows.

COMPATIBLE 0-10V DIMMERS and SWITCHES		
Manufacturer	Type	Dimming Curve
Busch-Jaeger	2112U-101	Logarithmic
Jung	240-10	Logarithmic
Leviton	IllumaTech - IP710-DLZ / IP710-LFZ	Logarithmic
Lightolier	ZP600FAM120	Logarithmic
Lutron	Diva; DVTV, DVSTV, NFTV Nova-T; NTSTV	Linear
Merten	5729	Logarithmic
Pass & Seymour	CD4FB-W	Logarithmic
Watt Stopper	DCLV1	Logarithmic
Sensor Switch	n O EZ	Linear
Synergy	ISD BC	Logarithmic

KIRLIN ARCHITECTURAL LIGHTING COMPONENTS ARE WARRANTED FREE OF DEFECTS IN WORKMANSHIP OR MATERIAL FOR FIVE YEARS FROM DATE OF PURCHASE. INSTALL TO N.E.C. IN NORMAL USE. Manufacturer at this option will replace or repair such product or refund the purchase price on presentation of proof of purchase and defective product at the offices of manufacturer within the year of original shipment. Liability of manufacturer is limited to the foregoing and manufacturer shall not be liable for any other damages, direct or indirect, sustained or suffered by purchaser or any person. This warranty is supplied to the buyer in place of all other warranties, expressed or implied. Seller does not warrant as to merchantability or fitness for a particular use, nor will any oral statement constitute a warranty or amend this specific warranty. Abnormal use, abuse of the product, improper installation, or repair, or modification of the product without prior written authorization from the manufacturer will render the warranty void.



Kirlin reserves the right to make changes without further notice to any products herein to improve reliability, function, or design. Kirlin does not assume any liability arising out of the application or use of any product described herein; neither does it convey any license under its patent rights, nor the rights of others.

Light Description	LED Driver Module		
	DVR-1400A	DVR-1050A	DVR-1400B
-1500L Luminaire	Up to 2 fixtures in series per driver		
-2500L Luminaire	1 fixture per driver		Up to 2 fixtures in series per driver
-4000L Luminaire		1 fixture per driver	
-5000L Luminaire	2 drivers per fixture		1 fixture per driver
-6500L Luminaire	2 drivers per fixture		

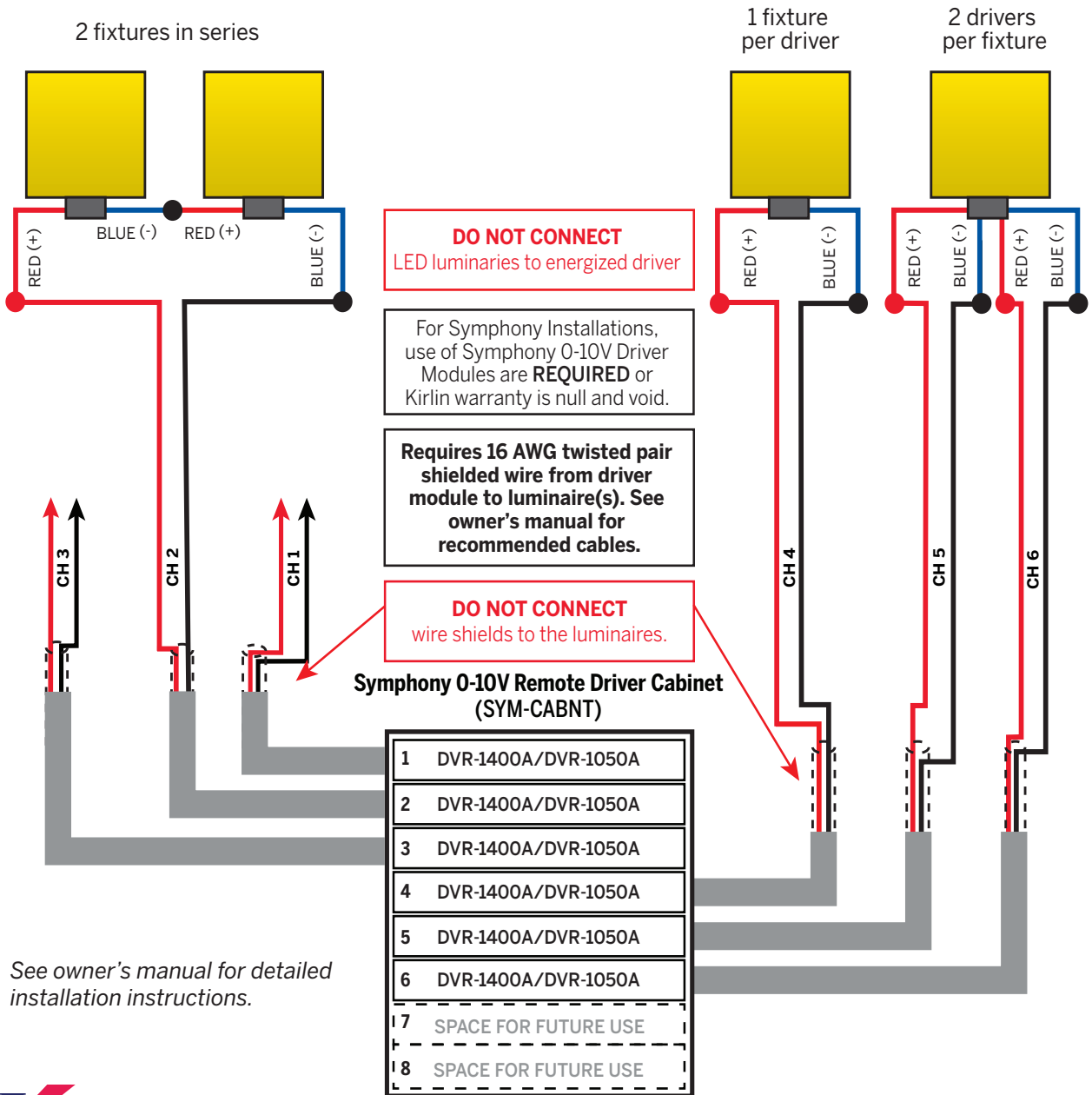

See owner's manual for detailed installation instructions.