

CATALOG #	TYPE	
JOB NAME	WATTAGE	VOLTAGE

7" x 9" 1 Quad 13 WATT MAXIMUM

VNT-07036

## Maximum Security NightLight: Quad 13

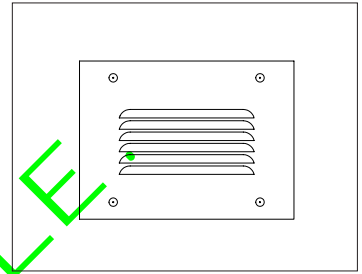

### Specifications

#### Lamp

- Designed for one horizontal 4-pin electronic quad 13W compact fluorescent lamp.

#### Ballast: Multi-Voltage

- Installed electronic high power factor, thermally protected.
- 120-277 multi-volt; 50-60 Hz. THD <10%.
- ClickQuick connectors for easy service.
- Cold weather -22°F (-30°C).
- End of lamp life protection circuit. RFI filter.
- Internally fused. Also see Option -FS.

#### Lens (Gasketed)

- Clear 1/4" polycarbonate behind louver.
- Secured between faceplate and housing by four center pin tamperproof screws and captive nuts.
- Gasketing between lens and faceplate.

#### Faceplate (Gasketed)

- White polyester enameled die-formed 16 gauge galvanized steel. Removable for servicing.

- Secured to housing by four center pin tamperproof screws and captive nuts.
- Gasketing between faceplate and wall.
- Tamperproof tool included.

#### Housing

- 16 gauge galvanized steel, formed and welded.
- White acrylic enamel finish.

#### Installation

- Recesses indoors or outdoors, covered locations.
- Minimum operating temperature: -22°F (-30°C).
- Ten 1/2" T.S. (7/8" dia.) wiring KO's.
- Mounting holes provided on top, bottom and ends for direct mounting to masonry or steel studs.
- Concrete Pour version available. See Option -78.

#### UL, C-UL (Canada) Listings

- Damp or dry locations, covered ceilings.
- Through-branch conductors (6 #12 AWG, 90°C).

#### Three Year Limited Warranty

- Complete standard fixture and ballast.

### Performance at a Glance

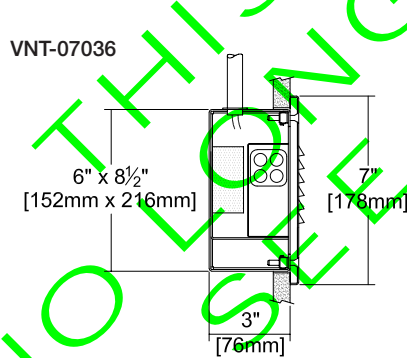

VNT-07036  
(1 Quad 13W)

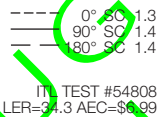

Footcandle Performance On the Floor - Top View  
(Installed 14" above finished floor.)

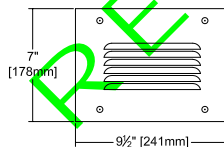
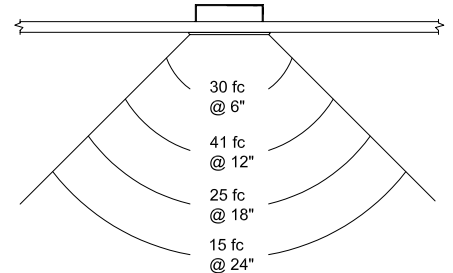

STANDARD  
TRIM

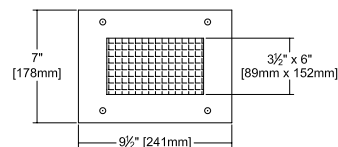

Lens  
Option -17

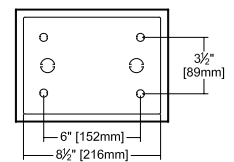

Housing KO's

## THE KIRLIN COMPANY

3401 EAST JEFFERSON AVENUE • DETROIT, MICHIGAN 48207-4232  
(313) 259-6400 • Fax: (313) 259-9409 OR (313) 259-3121 • www.kirlinlighting.com

ENERGY EFFICIENT VANDAL RESISTANT  
& MAXIMUM SECURITY LIGHTING

MAXIMUM WATTAGE

1 Quad 13

CATALOG NUMBER

VNT-07036

DUE TO OUR CONTINUING EFFORT TO IMPROVE PRODUCTS, TECHNICAL INFORMATION IS SUBJECT TO CHANGE WITHOUT NOTICE.

Detailed Photometry - Installed Fixture

Photometry from I.T.L., Boulder, CO

VNT-07036 (1 Quad 13)

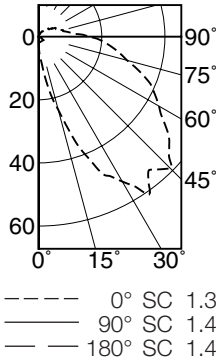

CANDLEPOWER DISTRIBUTION					
	0.0	45.0	90.0	135.0	180.0
0	2	2	2	2	2
10	15	9	2	0	0
30	53	37	2	0	0
50	54	44	2	0	0
70	35	29	1	0	0
90	16	11	0	0	0
110	7	4	0	0	0
130	4	2	0	0	0
150	2	1	0	0	0
170	0	0	0	0	0
180	0	0	0	0	0

COEFFICIENTS OF UTILIZATION							
RF	20						
	80						
RC	50		30		10		
RW	70	50	30	10	50	30	10
1	11	10	9	3	9	9	8
2	9	8	7	7	8	7	6
3	8	7	6	5	6	5	5
4	8	6	5	4	5	4	4
5	7	5	4	3	5	4	3
6	6	5	4	3	4	3	3
7	6	4	3	2	4	3	2
8	5	4	3	2	3	3	2
9	5	3	2	2	3	2	2
10	5	3	2	2	3	2	1

ITL TEST #54808 LER=34.0 •AEC=\$6.99

Options

Wattage and Voltage

- 43 Lower wattage. for 4-pin 9W twin.
- 75 Remote battery pack. Consult factory.
- 97 Specify other voltage. Consult factory.
- 98 347 volt, 50/60 Hz. input. Consult factory.

Luminaire (Faceplate/Frame) Finishes

- 35 Natural aluminum acrylic enamel.
- 36 Gold acrylic enamel.
- 37 Dark Bronze acrylic enamel.
- 38 Black acrylic enamel.
- 94 Custom color/finish. Specify. Consult factory.

Other

- 78 Concrete pour modification.
- 99 Special modification. Consult factory.
- FS Additional in-line fuse. Not available with Option -98(347V).
- LE With 4-pin electronic lamp. 3500°K standard. 82 CRI and 12,000 hour life. Specify wattage, style and color temperature.

Lens

- 17 Prismatic .187" high strength prismatic acrylic behind .220" clear polycarbonate and door (instead of louver).

SUBMITTAL DATA

APPROVAL STAMP

JOB NAME  
 TYPE  
 WATTAGE  
 VOLTAGE  
 CATALOG NUMBER

NO LONGER AVAILABLE. REPLACEMENT

LIMITED WARRANTY: CATALOGED KIRLIN FIXTURES ARE WARRANTED FREE OF DEFECTS IN WORKMANSHIP OR MATERIAL FOR THREE YEARS FROM DATE OF PURCHASE. INSTALL TO N.E.C. IN NORMAL USE. Manufacturer of the option will replace or repair such fixture or refund the purchase price on presentation of proof of purchase and defective fixture at the offices of manufacturer within three years of original shipment. Liability of manufacturer is limited to the foregoing and manufacturer shall not be liable for any other damages, direct or indirect, sustained or suffered by purchaser or any person. This warranty is subject to the buyer in place of all other warranties, expressed or implied. Seller does not warrant as to merchantability or fitness for a particular use, nor will any oral statement constitute a warranty or amend this specific warranty. Abnormal use, abuse of the fixture, improper installation, or repair or modification of the fixture without prior written authorization from the manufacturer will render the warranty void.