

CATALOG #	TYPE	
JOB NAME	WATTAGE	VOLTAGE

Symphony Remote Driver Series

Open Appearance 7" Adjustable • LED

Up to 60,000 Hour Rated Life (L70) • Wet Location

LM-80 Qualified • LM-79 Certified Photometry

SRR-07612

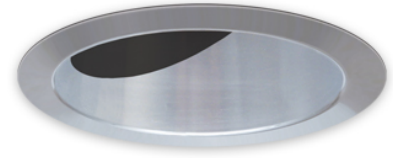

Specifications

Delivered System Performance

- Lumen Series: **Must Specify**
 - 6500L: 6500 nominal lumens (74W)
 - 5000L: 5000 nominal lumens (55W)
 - 4000L: 4000 nominal lumens (42W)
 - 2500L: 2500 nominal lumens (35W)
- Distributions: NFL standard; Optional: -SPT or -MFL
- Color temperature: 3500°K standard; Optional: -27K, -30K, -41K or -50K
- CRI: 80+ standard; Optional: -HC (90+)
- 60,000 hour rated life (L70)
- Fully sustainable: removable for servicing

Center Beam Optics

- Tilts up to 35° and locks in place
- Rotates full 360° and locks in place
- Accommodates sloped ceilings up to 35°

Thermal Management System

- All aluminum heat sink, components and housing maximize cool operation and long life while minimizing maintenance

Remote Power Supply Required

- For 0-10V use **SYM-CABNT**
- For DMX with RDM use **SYM-DMXPS**

- The **Symphony Configurator** can help determine the necessary components

SmartPower™ Battery Backup

- EMI-21220** for emergency power
- See specification sheet; order separately

Trim

- Clear specular aluminum trim
- Self-flanged, low glare angle-cut cone; prismatic spread lens above
- Optional colors and finishes available

Acrylic Enameled Aluminum Housing

- Rustproof and corrosion: Exceeds 1000 hour ASTM 5% salt spray test
- Shallow depth fits restricted plenums
- Cool operation: Extends life of all components
- Fully sustainable: Entire luminaire, including LED light engine, easily visible and serviced through aperture
- Built-in plaster flange

Outlet Box

- UL listed J-box with insulated removable cover. Prewired 14 GA (NEC) with 1/2" and 3/4" knockouts

Installation

- Requires minimum 16 AWG shielded twisted pair wire from driver to fixtures
- Maximum cable run from driver to fixture is 250'**
- Recesses in ceilings up to 1 1/8" thick
- Compatible with fire rated enclosures (by others)
- 27" galvanized hanger bars with adjustable mounting brackets (2) supplied

UL, C-UL (Canada) Listings

- Wet, damp, dry locations, covered ceilings
- 2500L (only): Type IC - for direct contact with insulation

FCC Compliance

- FCC Part 15 certified for EMI/RFI emissions

FIVE YEAR Limited Warranty

- Complete standard fixture (must be used with SYM-CABNT or SYM-DMXPS)

Options and Ordering Configuration

(Example: SRR-07612-6500L-30K-38F)



Must Specify		Optional			
Model	Lumens	Color Temp. (CCT)	Distribution	Lens & Trim	Other Options
SRR-07612					
	<ul style="list-style-type: none"> -6500L -5000L -4000L -2500L 	<ul style="list-style-type: none"> (Blank): 3500°K -27K: 2700°K instead -30K: 3000°K instead -41K: 4000°K instead -50K: 5000°K instead -HC: 90+ CRI instead 	<ul style="list-style-type: none"> (Blank): NFL -SPT: Spot distribution -MFL: Medium flood distribution 	<ul style="list-style-type: none"> (Blank): Clear specular trim; lens above -30T: White enamel (complete trim) -30F: White enamel (flange only) -37F: Dark bronze enamel (flange only) -38F: Black enamel (flange only) -45: Gasket between trim flange and ceiling -70T: Clear semi-specular SofTex™ (complete trim) -94: Custom color/finish; specify; consult factory -DL: Downlight version instead 	<ul style="list-style-type: none"> (Blank): None -99: Special modification; consult factory -AT: Air tight version; meets ASTM E283 restricted airflow of 2 CFM maximum -RH: Residential mounting hardware instead; suitable for wood joist ceilings with spacing from 14 1/8" to 25 7/8" with 5/8" vertical adjustability -SH: Sealed housing and junction box for -6500L or -5000L; see Option -AT for use with -2500L -TA: Top Access for servicing from above ceiling

Dimensions

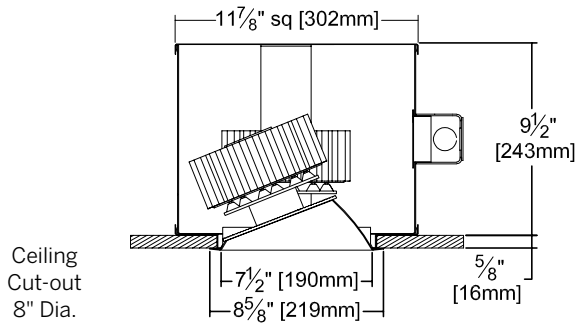

Ceiling Cut-out 8" Dia.

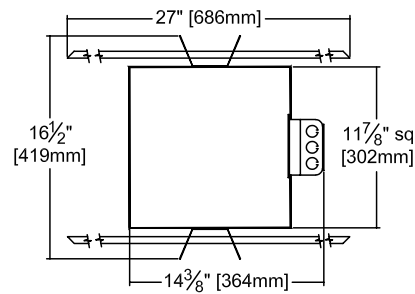

Photometry - Installed Complete Fixture

Photometry from I.T.L., Boulder, CO

LM-79 IESNA Certified Photometry from Independent Lab

-6500L STANDARD (NFL)

Lumens: 5206
Beam: ~39°
SC: 0.6
LPW: 71
Efficiency: 64.9%
ITL Test: 88085

Total System Watts 72.9

CANDLEPOWER DISTRIBUTION					
	0.0	45.0	90.0	135.0	180.0
0	3596	3596	3596	3596	3596
5	5144	4577	3449	2596	2316
15	8207	5970	2519	1141	902
25	9507	5643	1341	483	348
35	7926	3487	602	200	138
45	4076	1412	251	72	45
55	1274	458	80	19	11
65	275	105	16	8	1
75	20	7	3	0	0
85	1	0	0	0	0
90	0	0	0	0	0

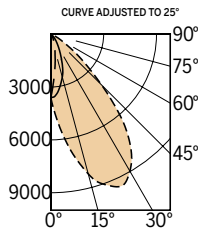

-6500L Option -SPT

Lumens: 5992
Beam: ~16°
SC: 0.3
LPW: 82
Efficiency: 74.7%
ITL Test: 86449

Total System Watts 73.2

CANDLEPOWER DISTRIBUTION					
	0.0	45.0	90.0	135.0	180.0
0	1576	1576	1576	1576	1576
5	3089	2505	1550	984	844
15	16886	4579	1263	402	327
25	45144	3867	610	230	186
35	15473	1556	271	135	103
45	2551	504	139	42	21
55	433	188	44	0	0
65	100	55	1	0	0
75	4	2	0	0	0
85	0	1	0	0	0
90	0	0	0	0	0

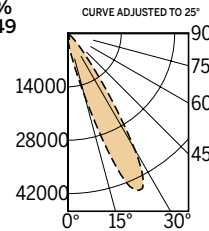

-6500L Option -MFL

Lumens: 5937
Beam: ~47°
SC: 0.9
LPW: 81
Efficiency: 74.0%
ITL Test: 86450

Total System Watts 73.3

CANDLEPOWER DISTRIBUTION					
	0.0	45.0	90.0	135.0	180.0
0	4507	4507	4507	4507	4507
5	7512	6395	4221	2673	2302
15	8725	7478	2396	973	701
25	8205	7507	1134	369	236
35	9019	4697	496	168	114
45	6702	1373	199	81	57
55	1480	423	79	33	20
65	312	119	26	7	3
75	35	16	3	1	1
85	0	0	0	0	0
90	0	0	0	0	0

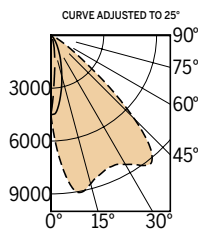

See following page for -5000L, -4000L and -2500L performance

LED manufacturers maintain a tolerance of +/-7% on flux (lumens) and power (electrical) measurements.

LIMITED WARRANTY: CATALOGED KIRLIN FIXTURES ARE WARRANTED FREE OF DEFECTS IN WORKMANSHIP OR MATERIAL FOR ONE YEAR FROM DATE OF PURCHASE. INSTALLED TO N.E.C. IN NORMAL USE. Manufacturer at the option will replace or repair such fixture or refund the purchase price on presentation of proof of purchase and defective fixture at the offices of manufacturer within the years of original shipment. Liability of manufacturer is limited to the foregoing and manufacturer shall not be liable for any other damages, direct or indirect, sustained or suffered by purchaser or any person. This warranty is applicable to the buyer in place of all other warranties, expressed or implied. Seller does not warrant as to merchantability or fitness for a particular use, nor will any oral statement constitute a warranty or amend this specific warranty. Abnormal use, abuse of the fixture, improper installation, or repair or modification of the fixture without prior written authorization from the manufacturer will render the warranty void.

SYMPHONY
NOVEMBER 2024

Detailed Photometry - Installed Fixture

Photometry from I.T.L., Boulder, CO

SRR-07612-5000L PERFORMANCE

-5000L STANDARD (NFL)

Lumens: 4829
Beam: ~32°
SC: 0.6
LPW: 84
Efficiency: 81.3%
ITL Test: 87785

Total System Watts 57.2

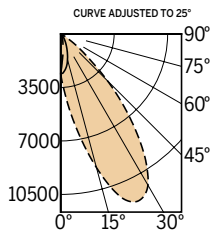

CANDLEPOWER DISTRIBUTION					
	0.0	45.0	90.0	135.0	180.0
0	2595	2595	2595	2595	2595
5	4265	3630	2479	1741	1529
15	9052	5410	1726	733	567
25	12050	5045	908	355	254
35	9475	2830	430	153	103
45	4334	1053	178	51	30
55	979	286	50	9	4
65	149	59	7	2	0
75	9	3	1	0	0
85	0	0	0	0	0
90	0	0	0	0	0

SRR-07612-4000L PERFORMANCE

-4000L STANDARD (NFL)

Lumens: 3883
Beam: ~33°
SC: 0.5
LPW: 91
Efficiency: 81.4%
ITL Test: 88282

Total System Watts 42.7

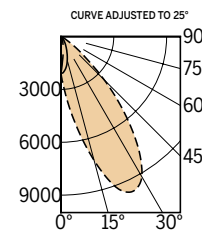

CANDLEPOWER DISTRIBUTION					
	0.0	45.0	90.0	135.0	180.0
0	2086	2086	2086	2086	2086
5	3429	2919	1993	1400	1229
15	7278	4350	1388	589	456
25	9688	4056	730	285	204
35	7618	2275	346	123	83
45	3485	847	143	41	24
55	787	230	40	7	3
65	120	47	6	2	0
75	7	2	1	0	0
85	0	0	0	0	0
90	0	0	0	0	0

-5000L Option -SPT

Lumens: 4858
Beam: ~16°
SC: 0.3
LPW: 84
Efficiency: 81.7%
ITL Test: 87774

Total System Watts 57.6

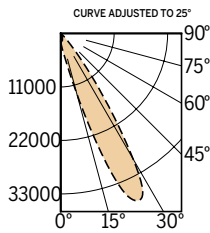

CANDLEPOWER DISTRIBUTION					
	0.0	45.0	90.0	135.0	180.0
0	1612	1612	1612	1612	1612
5	2807	2383	1605	1090	901
15	12753	3770	1377	443	308
25	37895	3026	699	229	161
35	13371	1303	224	114	83
45	1557	456	103	34	13
55	273	139	26	0	0
65	52	27	0	0	0
75	1	1	0	0	0
85	0	0	0	0	0
90	0	0	0	0	0

-4000L Option -SPT

Lumens: 3906
Beam: ~16°
SC: 0.3
LPW: 91
Efficiency: 81.9%
ITL Test: 88283

Total System Watts 43.0

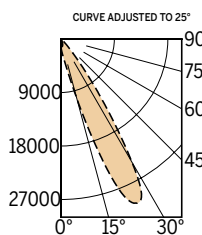

CANDLEPOWER DISTRIBUTION					
	0.0	45.0	90.0	135.0	180.0
0	1296	1296	1296	1296	1296
5	2257	1916	1290	876	724
15	10253	3031	1107	356	248
25	30468	2433	562	184	129
35	10750	1048	180	92	67
45	1252	367	83	27	10
55	219	112	21	0	0
65	42	22	0	0	0
75	1	1	0	0	0
85	0	0	0	0	0
90	0	0	0	0	0

-5000L Option -MFL

Lumens: 4893
Beam: ~45°
SC: 0.8
LPW: 85
Efficiency: 82.3%
ITL Test: 87775

Total System Watts 57.5

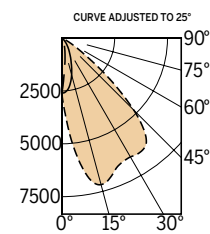

CANDLEPOWER DISTRIBUTION					
	0.0	45.0	90.0	135.0	180.0
0	2609	2609	2609	2609	2609
5	4692	4006	2517	1692	1475
15	7174	6605	1796	730	542
25	6560	6312	961	336	212
35	6543	3782	475	161	95
45	4815	1383	193	69	42
55	1176	379	67	22	9
65	177	93	15	1	0
75	22	8	0	0	0
85	1	0	0	0	0
90	0	0	0	0	0

-4000L Option -MFL

Lumens: 3934
Beam: ~45°
SC: 0.8
LPW: 92
Efficiency: 82.5%
ITL Test: 88284

Total System Watts 43.0

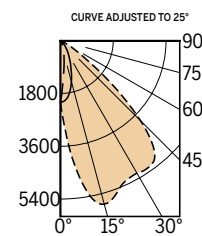

CANDLEPOWER DISTRIBUTION					
	0.0	45.0	90.0	135.0	180.0
0	2098	2098	2098	2098	2098
5	3772	3221	2024	1360	1186
15	5768	5310	1444	587	436
25	5274	5075	773	270	170
35	53871	3041	382	129	76
45	3871	1112	155	55	34
55	946	305	54	18	7
65	142	75	12	1	0
75	18	6	0	0	0
85	1	0	0	0	0
90	0	0	0	0	0

See following page for -2500L performance

LED manufacturers maintain a tolerance of +/-7% on flux (lumens) and power (electrical) measurements.

LIMITED WARRANTY: CATALOGED KIRLIN FIXTURES ARE WARRANTED FREE OF DEFECTS IN WORKMANSHIP OR MATERIAL FOR FIVE YEARS FROM DATE OF PURCHASE. INSTALLED TO N.E.C. IN NORMAL USE. Manufacturer at his option will replace or repair such fixture or refund the purchase price on presentation of proof of purchase and defective fixture at the offices of manufacturer within five years of original shipment. Liability of manufacturer is limited to the foregoing, and manufacturer shall not be liable for any other damages, direct or indirect, sustained or suffered by purchaser or any person. This warranty is void where prohibited by law. Seller does not warrant as to merchantability or fitness for a particular use, nor will any oral statement constitute a warranty or amend this specific warranty. Abnormal use, abuse of the fixture, improper installation, or repair, or modification of the fixture without prior written authorization from the manufacturer will render the warranty void.

Detailed Photometry - Installed Fixture

Photometry from I.T.L., Boulder, CO

LIMITED WARRANTY: CATALOGED KIRLIN FIXTURES ARE WARRANTED FREE OF DEFECTS IN WORKMANSHIP OR MATERIAL FOR FIVE YEARS FROM DATE OF PURCHASE. INSTALLED TO N.E.C. IN NORMAL USE. Manufacturer at the option will replace or repair such fixture or refund the purchase price on presentation of proof of purchase and defective fixture at the offices of manufacturer within the years of original shipment. Liability of manufacturer is limited to the foregoing and manufacturer shall not be liable for any other damages, direct or indirect, sustained or suffered by purchaser or any person. This warranty is supplied to the buyer in place of all other warranties, expressed or implied. Seller does not warrant as to merchantability or fitness for a particular use, nor will any oral statement constitute a warranty or amend this specific warranty. Abnormal use, abuse of the fixture, improper installation, or repair or modification of the fixture without prior written authorization from the manufacturer will render the warranty void.

SRR-07612-2500L PERFORMANCE

-2500L STANDARD (NFL)

Lumens: 2832
 Beam: ~33°
 SC: 0.6
 LPW: 81
 Efficiency: 76.2%
 ITL Test: 87787

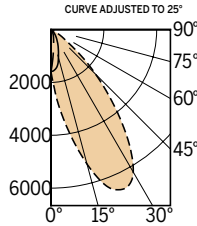

Total System Watts 35.2

CANDLEPOWER DISTRIBUTION					
	0.0	45.0	90.0	135.0	180.0
0	1584	1584	1584	1584	1584
5	2692	2203	1534	1104	957
15	5268	3192	1091	493	383
25	6631	2866	618	261	186
35	5073	1653	328	118	77
45	2390	734	138	37	21
55	608	215	37	6	3
65	105	35	4	1	0
75	7	2	1	1	0
85	1	0	0	0	0
90	0	0	0	0	0

-2500L Option -SPT

Lumens: 3056
 Beam: ~15°
 SC: 0.3
 LPW: 87
 Efficiency: 82.2%
 ITL Test: 87771

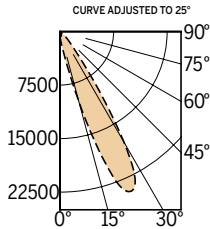

Total System Watts 35.1

CANDLEPOWER DISTRIBUTION					
	0.0	45.0	90.0	135.0	180.0
0	661	661	661	661	661
5	1477	1138	657	397	328
15	10096	2231	549	183	146
25	24345	1832	337	122	101
35	7106	793	140	66	52
45	1344	282	63	17	7
55	199	75	11	0	0
65	38	11	0	0	0
75	1	0	0	0	0
85	0	0	0	0	0
90	0	0	0	0	0

-2500L Option -MFL

Lumens: 3048
 Beam: ~45°
 SC: 0.8
 LPW: 87
 Efficiency: 82.0%
 ITL Test: 87772

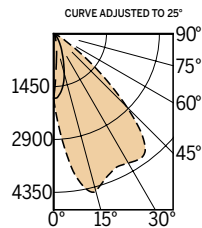

Total System Watts 35.0

CANDLEPOWER DISTRIBUTION					
	0.0	45.0	90.0	135.0	180.0
0	1772	1772	1772	1772	1772
5	3019	2688	1693	1032	844
15	4466	4339	1125	381	264
25	4050	3978	537	167	107
35	4167	2341	256	83	56
45	2834	825	117	39	26
55	764	255	42	13	6
65	139	65	10	1	0
75	7	3	0	0	0
85	0	0	0	0	0
90	0	0	0	0	0

LED manufacturers maintain a tolerance of +/-7% on flux (lumens) and power (electrical) measurements.

Symphony Driver Modules

Fully Digital Controlled Power Source for LED Luminaires

Mounted in Kirlin's **SYM-CABNT**

Drivers wired in series



Driver Module	Maximum Capacity	Fixture Load Examples
DVR-1400A	Qty 1: 2500L Luminaires	<ul style="list-style-type: none"> Qty 1: SRR-07612-2500L
DVR-1400B *Not available with DMX dimming	Up to Qty 2: 2500L Luminaires	<ul style="list-style-type: none"> Qty 1: SRR-07612-2500L Qty 2: SRR-07612-2500L Qty 1: SRR-07612-2500L and Qty 1: SRR-07604-2500L
DVR-1050A	Qty 1: 4000L Luminaires	<ul style="list-style-type: none"> Qty 1: SRR-07612-4000L
DVR-1400B	Qty 1: 5000L Luminaires	<ul style="list-style-type: none"> Qty 1: SRR-07612-5000L
DVR-1400A *Not available with DMX dimming	Qty .5: 6500L Luminaires	<ul style="list-style-type: none"> Qty 1: SRR-07612-6500L requires Qty 2: DVR-1400A