

### Healthcare: MRI

#### NON-MAGNETIC CONSTRUCTION FOR MRI USE

Fixture shall be built of non-magnetic materials and suitable for use in M.R.I. (Magnetic Resonance Imaging) Rooms.

Lamp to be suitable for operation on D.C. circuits.

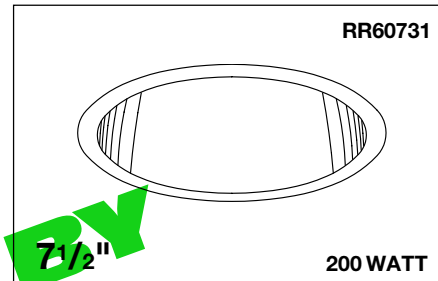

Wall Wash Optional

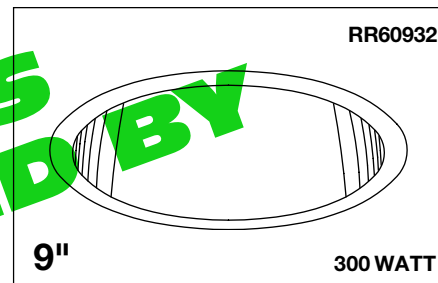

Downlight Illumination

### Features

#### Lamp

- Designed for: 200 watt (maximum) frosted A21- RR60731, 300 watt (maximum) inside frosted PS-25- RR60932.
- For operation on D.C. circuits.

#### Socket

- Vertical, Medium base.
- Glazed porcelain.
- Nickel-plated brass screw shell. Silicone leads.

#### Reflector

- Self-flanged specular Alzak® aluminum.
- Wall wash available. (Option -WW for RR60731)

#### Housing

- Acrylic enameled aluminum.
- Cool: Dissipates heat across entire surface area.

- Rustproof: Exceeds 1000 hour ASTM 5% salt spray test.
- Entire luminaire serviced through removable reflector.
- Built-in plaster frame.

#### Outlet Box

- 100% aluminum.

#### Installation

- 27" aluminum bar hangers supplied (2).
- Fully adjustable non-magnetic universal mounting brackets supplied (2).

#### UL, C-UL (Canada) Listings

- Wet, damp or dry locations, covered ceilings.
- Through-branch circuit conductors (up to 6#12).

#### Three Year Limited Warranty

- Complete standard fixture.

#### Thermal Protection

- Per current NEC.

NOT RESTRICTED TO END-OF-RUN USE

### Performance at a Glance

RR60731

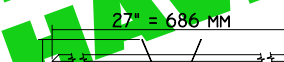
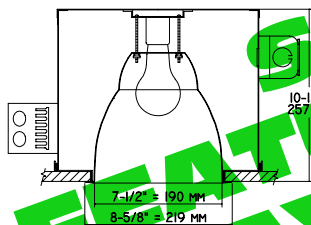

RR60932

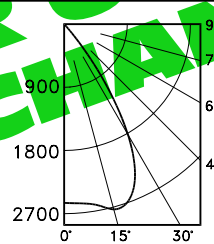
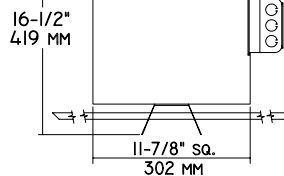
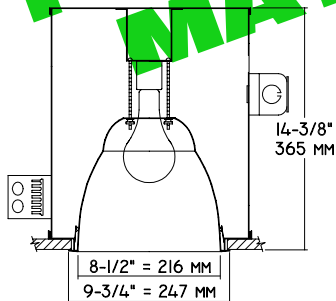

RR60731 S/MH 1.0

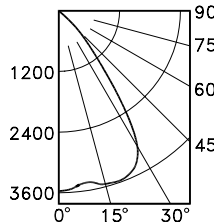

RR60932 S/MH 1.1

#### Cone of Light\*

Ft.	FC	Dia.
6	70.4	6.6
8	39.6	8.8
10	25.4	11.0
12	17.6	13.2
14	12.9	15.4
16	9.9	17.6

RR60731

#### Cone of Light Key

Ft. Mounting height  
FC Footcandles  
Dia. Circle of light at 50% of FC

\* Dia. (in ft.) shown is where FC value is half the FC at nadir.

#### Cone of Light\*

Ft.	FC	Dia.
6	97.1	7.2
8	54.6	9.6
10	35.0	12.0
12	24.3	14.3
14	17.8	16.7
16	13.7	19.1

RR60932

## THE KIRLIN COMPANY

3401 EAST JEFFERSON AVENUE • DETROIT, MICHIGAN 48207-4232  
(313) 259-6400 • Fax: (313) 259-9409 OR (313) 259-3121

MRI INCANDESCENT  
HEALTHCARE LIGHTING

LAMP

A21  
PS-25

MAXIMUM WATTAGE

200  
300

CATALOG NUMBERS

RR60731  
RR60932

RR60731  
RR60932

RECESSED ROUND: 200 and 300 WATT MRI INCANDESCENT DOWNLIGHT

**KIRLIN**

Detailed Photometry - Installed Fixture

FROM I.T.L. (BOULDER, CO)

RR60731

CANDLEPOWER DISTRIBUTION

COEFFICIENTS OF UTILIZATION

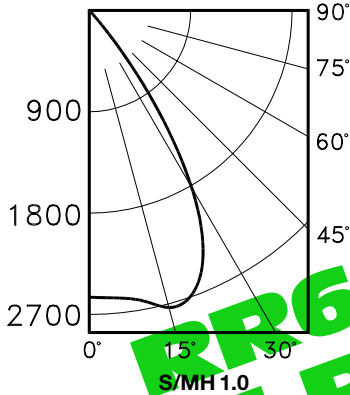

	0.0	45.0	90.0	135.0	180.0
0	2535	2535	2535	2535	2535
5	2583	2583	2583	2583	2583
15	2796	2796	2796	2796	2796
25	2430	2430	2430	2430	2430
35	1074	1074	1074	1074	1074
45	79	79	79	79	79
55	6	6	6	6	6
65	0	0	0	0	0
75	0	0	0	0	0
85	0	0	0	0	0
90	0	0	0	0	0

RF	20						
	80			50			
	RW	70	50	30	10	50	30
1	81	79	78	76	75	74	72
2	77	74	71	69	70	69	66
3	74	69	66	63	66	63	61
4	70	65	61	58	62	59	57
5	66	60	56	53	59	55	53
6	63	57	53	49	55	52	49
7	60	53	49	46	52	48	46
8	57	50	46	43	49	45	43
9	54	47	43	40	46	43	40
10	52	45	41	38	44	40	38

EFFICIENCY = 71.5%

RR60932

CANDLEPOWER DISTRIBUTION

COEFFICIENTS OF UTILIZATION

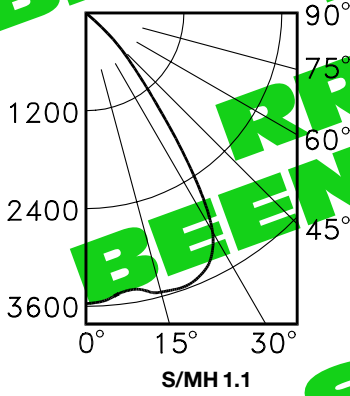

	0.0	45.0	90.0	135.0	180.0
0	3496	3496	3496	3496	3496
5	3492	3492	3492	3492	3492
15	3558	3558	3558	3558	3558
25	3490	3490	3490	3490	3490
35	2164	2164	2164	2164	2164
45	486	486	486	486	486
55	11	11	11	11	11
65	4	4	4	4	4
75	1	1	1	1	1
85	0	0	0	0	0
90	0	0	0	0	0

RF	20						
	80			50			
	RW	70	50	30	10	50	30
1	83	81	79	77	76	75	73
2	78	75	72	69	71	69	67
3	74	69	65	62	66	63	61
4	70	64	60	57	62	58	56
5	66	60	55	52	58	54	51
6	62	56	51	48	54	50	47
7	59	52	47	44	50	46	44
8	56	48	44	41	47	43	40
9	53	45	41	38	44	40	37
10	50	43	38	35	42	38	35

EFFICIENCY = 73.0%

Estimated Multiplier  
-16 Champagne Gold Alzak® (CP x .90)

Options

- 16 Champagne Gold anodized Alzak reflector. (CP x .90)
- 31 White reflector flange.
- 45 Gasket between trim and ceiling. (Minimizes dust streaks on ceiling.)
- 94 Custom color reflector or flange. Consult factory.
- 99 Special modification. Consult factory.
- DW Double wall wash. 180° opposite (RR60731 only).
- WW Wall wash specular Alzak reflector instead. 360° adjustment (RR60731 only).

SUBMITTAL DATA

APPROVAL STAMP

JOB NAME \_\_\_\_\_

TYPE \_\_\_\_\_

WATTAGE \_\_\_\_\_ VOLTAGE \_\_\_\_\_

CATALOG NUMBER \_\_\_\_\_

LIMITED WARRANTY: CATALOGUED KIRLIN FIXTURES ARE WARRANTED FREE OF DEFECTS IN WORKMANSHIP OR MATERIAL FOR THREE YEARS FROM DATE OF PURCHASE. INSTALLATION MUST BE IN ACCORDANCE WITH THE MANUFACTURER'S INSTRUCTIONS. THE WARRANTY IS VOID IF THE FIXTURE IS NOT INSTALLED IN ACCORDANCE WITH THE MANUFACTURER'S INSTRUCTIONS. THE WARRANTY IS VOID IF THE FIXTURE IS USED IN AN APPLICATION NOT INTENDED BY THE MANUFACTURER. THE WARRANTY IS VOID IF THE FIXTURE IS REPAIRED OR MODIFIED WITHOUT THE WRITTEN AUTHORIZATION OF THE MANUFACTURER. THE WARRANTY IS VOID IF THE FIXTURE IS USED IN AN APPLICATION NOT INTENDED BY THE MANUFACTURER. THE WARRANTY IS VOID IF THE FIXTURE IS REPAIRED OR MODIFIED WITHOUT THE WRITTEN AUTHORIZATION OF THE MANUFACTURER.