

PAR 20 / PAR 30 Downlights in Small Apertures

Features

Lamp

- Designed for:
 - 39 watt PAR 20 metal halide: RR40425.
 - 70 watt PAR 30 metal halide: RR40626.
- 10° spot standard. As options, 30° medium flood (RR40425) or 40° medium flood (RR40626) beam spreads available.
- See Option -43 for lower wattage.

Socket

- Vertical. Medium base. Pulse rated.
- Glazed porcelain.
- Nickel-plated brass screw shell. Silicone leads.

Reflector

- Self-flanged specular Alzak® aluminum.
- Ten optional reflector finishes available.

Ballast Assembly

- WhisperPack™ fully encapsulated 180°C rated HPF ballast.
- Premium Class H; High reactance 5:7 regulation.
- Capacitor and ignitor supplied.
- 120 volt standard or see optional voltages.
- Cool, quiet, long-life. Silicone leads.
- Visible and easily serviced in all ceilings including dry wall.

Fuse

- Fused primary. Renewable. Aids servicing.

Housing

- Acrylic enameled aluminum.
- Cool: Dissipates heat across entire surface area. Ventilated.
- Rustproof: Exceeds 1000 hour ASTM 5% salt spray test.
- Entire luminaire serviced through removable reflector. For top access see Option -TA.
- Built-in plaster frame.

Outlet Box

- Prewired 14 GA (NEC) galvanized steel, UL listed; with removable insulated cover.
- 1/2" and 3/4" knockouts.

Installation

- 27" galvanized hanger bars supplied (2).
- Fully adjustable universal mounting brackets supplied (2).
- Recesses indoor or outdoor in covered locations.

UL, C-UL (Canada) Listings

- Wet, damp or dry locations, covered ceilings.
- Through-branch circuit conductors (6 #12).

Three Year Limited Warranty

- Complete standard fixture.

Thermal Protection

- Per current NEC.

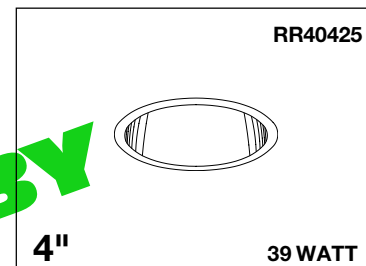

For Master Color Lamps

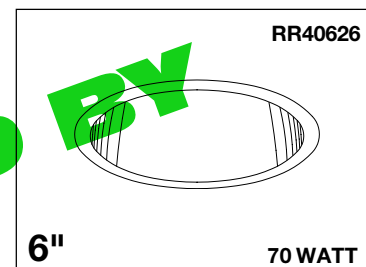

Master Color, Metalarc or G.E. Lamps

Performance at a Glance

RR40425

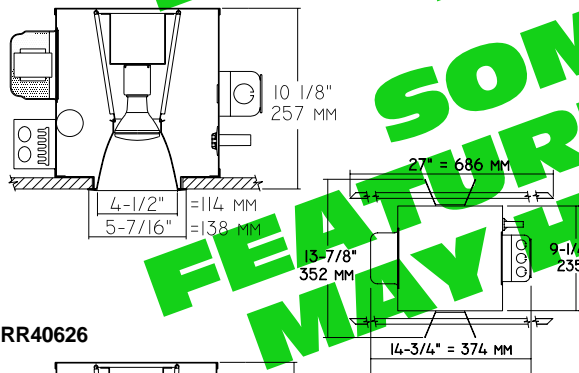

RR40425 (10° Narrow Spot Shown)

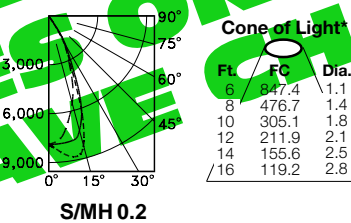

RR40425 (30° Medium Flood Shown)

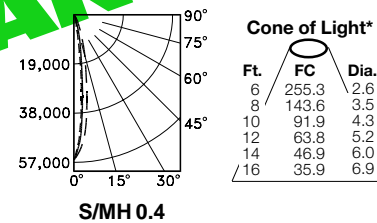

RR40626

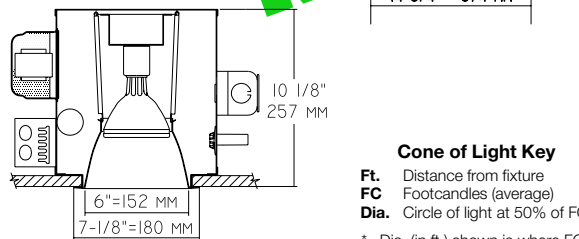

RR40626 (10° Narrow Spot Shown)

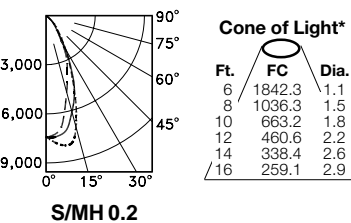

RR40626 (40° Medium Flood Shown)

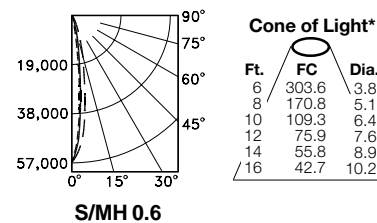

Cone of Light Key

- Ft. Distance from fixture
 - FC Footcandles (average)
 - Dia. Circle of light at 50% of FC
- * Dia. (in ft.) shown is where FC value is half the FC at nadir.

THE KIRLIN COMPANY

3401 EAST JEFFERSON AVENUE • DETROIT, MICHIGAN 48207-4232
(313) 259-6400 • Fax: (313) 259-9409 OR (313) 259-3121 • www.light-link.com/kirlin

HIGH EFFICIENCY
METAL HALIDE LIGHTING

LAMP
PAR 20
PAR 30

MAXIMUM WATTAGE
39
70

CATALOG NUMBERS
RR40425
RR40626

**RR40425
RR40626**

RECESSED ROUND: 39 and 70 WATT MEDIUM BASE METAL HALIDE



Detailed Photometry - Installed Fixture

FROM I.T.L. (BOULDER, CO)

RR40425 (SPOT): TEST No. 49884
RR40626 (SPOT): TEST No. 49878

RR40425 (MFL): TEST No. 49885
RR40626 (MFL): TEST No. 49879

RR40425 (10° Narrow Spot)

*LER = 10.1 •AEC = \$23.77

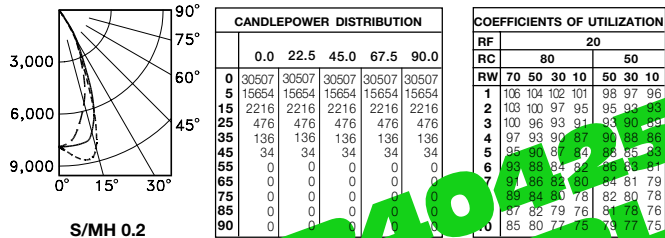

S/MH 0.2
EFFICIENCY = 91.4%

RR40425 (30° Medium Flood)

*LER = 11.9 •AEC = \$20.22

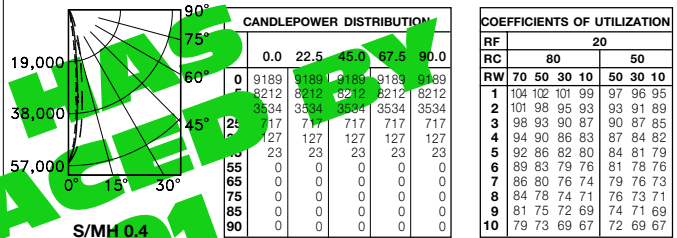

S/MH 0.4
EFFICIENCY = 90.7%

RR40626 (10° Narrow Spot)

*LER = 10.4 •AEC = \$23.04

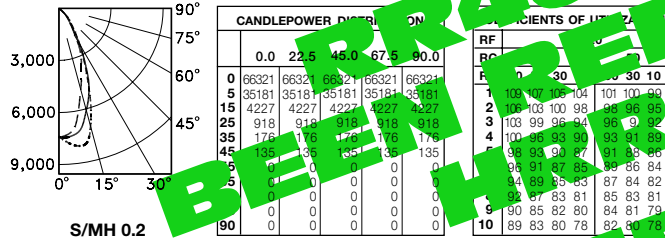

S/MH 0.2
EFFICIENCY = 94.2%

RR40626 (40° Medium Flood)

*LER = 12.5 •AEC = \$19.21

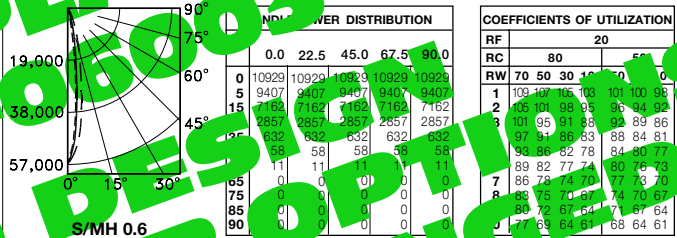

S/MH 0.6
EFFICIENCY = 95.5%

- Estimated Multipliers**
- 16 Champagne Gold Alzak®: CP x .98
 - 30 White: CP x .95
 - 63 Dune Alzak: CP x .97
 - 69 Wheat Alzak: CP x .97
 - 70 Clear SoftTex: CP x .98
 - 71 Dune SoftTex: CP x .96
 - 72 Black Alzak: CP x .87
 - 90 Champagne Gold SoftTex: CP x .96
 - 91 Wheat SoftTex: CP x .95
 - 93 Pewter Alzak: CP x .95
 - OG OptiGroove: CP x .90

Options

- 16 Champagne Gold anodized Alzak self-flanged reflector. (CP x .98)
- 30 All white self-flanged reflector. (CP x .98)
- 31 White flange (only) on self-flanged reflector.
- 32 Trim extender. Broadens trim flange O.D. by 1" to cover larger ceiling opening.
- 43 Lower wattage - specify wattage and voltage: 39 watt PAR 20 (RR40626 only).
- 45 Gasket above reflector flange. Stops dust streaks on ceiling.
- 58 277 volt 60 Hz. ballast instead.
- 63 Dune specular Alzak self-flanged reflector. (CP x .97)
- 69 Wheat specular Alzak self-flanged reflector. (CP x .97)
- 70 SoftTex Clear softly etched self-flanged reflector. (CP x .98)
- 71 SoftTex Dune softly etched self-flanged reflector. (CP x .95)
- 72 Black anodized Alzak self-flanged reflector. (CP x .87)
- 79 Extension collar for up to 2" thick ceilings.
- 82 Sloped ceiling adapter for RR40626 only, with mounting hardware. Specify 5° increments up to 30°.
- 90 SoftTex Champagne Gold softly etched self-flanged reflector. (CP x .96)
- 91 SoftTex Wheat softly etched self-flanged reflector. (CP x .95)
- 93 Pewter anodized Alzak self-flanged reflector. (CP x .95)
- 94 Custom color self-flanged reflector. Consult factory.
- 97 Other voltage ballast. Consult factory.
- 99 Special modification. Consult factory.
- LP With 10° spotlamp. Specify wattage, beam spread and style (PAR 20, PAR 30) and color temperature. Also available for RR40425: 30° medium flood; RR40626: 40° medium flood.
- OG OptiGroove black seamless tapered aluminum reflector. White trim, self-flanged. (CP x .90)

SUBMITTAL DATA

JOB NAME _____

TYPE _____

WATTAGE _____ VOLTAGE _____

CATALOG NUMBER _____

APPROVAL STAMP

LIMITED WARRANTY: CATALOGUED KIRLIN FIXTURES ARE WARRANTED FREE OF DEFECTS IN WORKMANSHIP OR MATERIAL FOR THREE YEARS FROM DATE OF PURCHASE. INSTALLATION TO N.E.C. OR NORMAL USE. Manufacturer at this option will replace or repair such fixture or refund the purchase price on presentation of proof of purchase and defective fixture at the office of manufacturer within three years of original shipment. Liability of manufacturer is limited to the foregoing, and manufacturer shall not be liable for any other damages, direct or indirect, sustained or suffered by purchaser or any person. This warranty is supplied to the purchaser in place of all other warranties, expressed or implied. Seller does not warrant as to merchantability or fitness for a particular use; no warranty shall be implied. A disclaimer of any other warranty is hereby made. This warranty is void where prohibited by law. The manufacturer will order the warranty void.