

Type IC PAR 38 Halogen Downlights

Features

Lamp / Socket

- Designed for: 120 watt (max.) PAR 38 tungsten halogen lamp (by others).
- Rated 3000 hour life; 100 CRI.
- Dimmable (controls by others).
- Glazed porcelain medium base socket.

Reflector

- Self-flanged parabolic specular Alzak® aluminum.
- Eleven optional self-flanged colors and finishes available. See Options.

Housing

- Acrylic enameled 100% aluminum.
- Rustproof: Exceeds 1000 hour ASTM 5% salt spray test.
- Cool: Dissipates heat across entire surface area.
- Entire luminaire visible and serviceable from below through removable reflector.
- Built-in plaster frame. Also see Option -79.

Outlet Box

- Prewired 14GA (NEC) galvanized steel. UL

- listed. With removable insulated cover.
- 1/2" and 3/4" knockouts.

Installation

- 27" galvanized hanger bars supplied (2).
- Fully adjustable universal galvanized mounting brackets supplied (2). Accepts 3/4" or 1-1/4" lathers channel or 1/2" T.S. conduit.
- Recesses indoor or outdoor in covered ceilings.

UL, C-UL (Canada) Listings

- Wet, damp or dry locations, covered ceilings.
- Through-branch circuit conductors (6 #12 AWG 90°C).
- Type IC - Approved for direct contact with insulation.

Three Year Limited Warranty

- Complete standard fixture.
- Thermal Protection (Per Current NEC) Thermal protector included which provides automatic cut-off if rated wattage is exceeded.

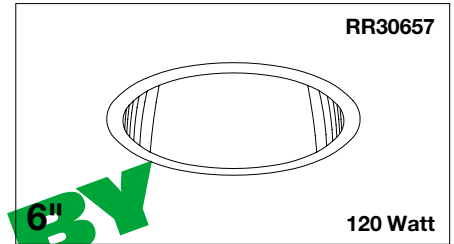

Type IC - Approved for Direct Contact with Insulation
Dimmable
11 Optional Reflector Finishes

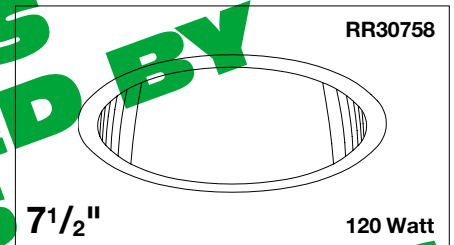

Performance at a Glance

RR30657

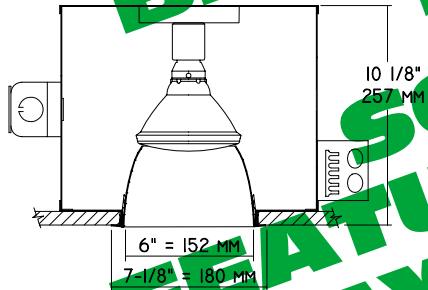

RR30758

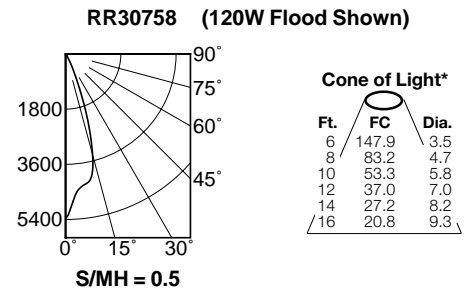
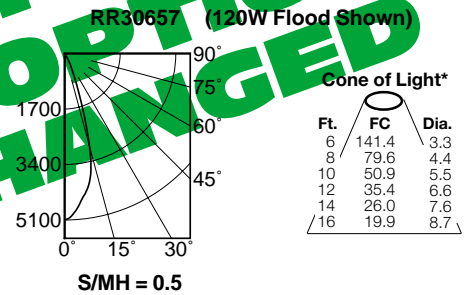
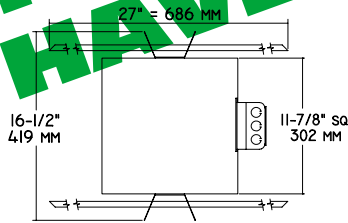
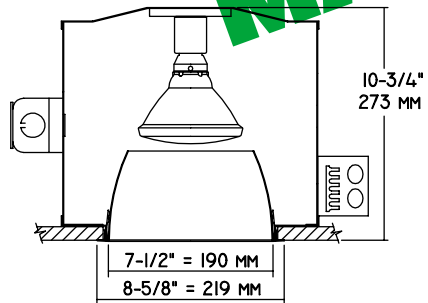

Cone of Light Key
Ft. Distance from fixture
FC Footcandles (average)
Dia. Circle of light at 50% of FC

* Dia. (in ft.) shown is where FC value is half the FC at nadir.

THE KIRLIN COMPANY

3401 EAST JEFFERSON AVENUE • DETROIT, MICHIGAN 48207-4232
(313) 259-6400 • Fax: (313) 259-9409 OR (313) 259-3121 • www.kirlinlighting.com

NEW MILLENNIUM

TUNGSTEN HALOGEN and
INCANDESCENT LIGHTING

LAMP

PAR 38
PAR 38

MAXIMUM WATTAGE

120
120

CATALOG NUMBERS

RR30657
RR30758

Detailed Photometry - Installed Fixture

FROM I.T.L. (BOULDER, CO) RR30657 (120W FL): TEST # 47279
RR30758 (120W FL): TEST # 47282

RR30657 120W FL

CANDLEPOWER DISTRIBUTION

COEFFICIENTS OF UTILIZATION

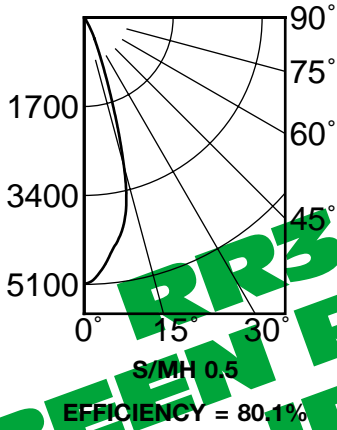

	0.0	22.5	45.0	67.5	90.0
0	5092	5092	5092	5092	5092
5	4720	4720	4720	4720	4720
15	2936	2936	2936	2936	2936
25	525	525	525	525	525
30	64	64	64	64	64
40	23	23	23	23	23
55	0	0	0	0	0
60	0	0	0	0	0
75	0	0	0	0	0
90	0	0	0	0	0

RF	20					50				
	70	80	90	10	50	30	10	50	30	10
1	92	90	89	87	85	84	83	89	87	85
2	89	86	84	81	82	80	79	86	84	82
3	86	82	79	77	79	77	75	83	81	79
4	83	79	76	73	76	74	72	80	78	76
5	81	76	72	70	74	71	69	77	75	73
6	78	73	69	67	71	68	66	74	72	70
7	76	70	67	64	69	66	64	71	69	67
8	73	68	65	62	67	64	62	68	66	64
9	71	66	62	60	65	62	60	66	64	62
10	69	64	60	58	63	60	58	64	62	60

RR30758 120W FL

CANDLEPOWER DISTRIBUTION

COEFFICIENTS OF UTILIZATION

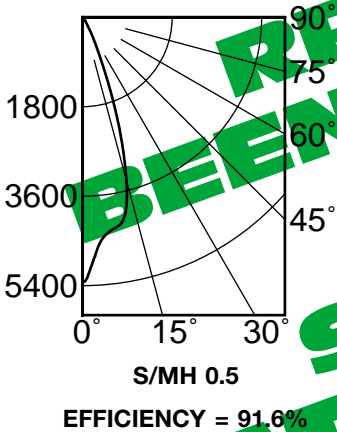

	0.0	22.5	45.0	67.5	90.0
0	5326	5326	5326	5326	5326
5	4483	4483	4483	4483	4483
15	3403	3403	3403	3403	3403
20	661	661	661	661	661
30	97	97	97	97	97
45	21	21	21	21	21
55	0	0	0	0	0
65	0	0	0	0	0
75	0	0	0	0	0
90	0	0	0	0	0

RF	20					50				
	70	80	90	10	50	30	10	50	30	10
1	105	103	101	100	98	96	95	104	102	100
2	102	98	95	93	94	92	90	101	97	94
3	98	93	90	87	91	87	85	98	94	91
4	95	89	86	83	87	84	81	95	91	88
5	91	86	82	79	83	80	78	92	88	85
6	88	82	78	75	80	77	75	89	85	82
7	86	79	75	72	78	74	72	86	82	79
8	83	76	72	70	75	72	69	83	79	76
9	80	74	70	67	73	69	67	80	76	73
10	78	71	67	65	70	67	64	78	74	71

Estimated Multipliers

- 16 Champagne Gold Alzak®: CP x .98
- 30 White: CP x .98
- 93 Dune Alzak: CP x .97
- 69 Wheat Alzak: CP x .97
- 70 SofTex Clear: CP x .98
- 71 SofTex Dune: CP x .95
- 72 Black Alzak: CP x .80
- 90 SofTex Champagne Gold: CP x .96
- 91 SofTex Wheat: CP x .95
- 93 Pewter Alzak: CP x .95
- OG Black OptiGroove: CP x .82

Options

- 16 Champagne Gold specular Alzak self-flanged reflector. (CP x .98)
- 30 All white reflector, self-flanged. (CP x .98)
- 31 White flange (only) on self-flanged reflector.
- 32 Trim extender. Broadens trim flange O.D. by 1" to cover larger ceiling opening.
- 45 Gasket above reflector flange. Stops dust streaks on ceiling.
- 63 Dune specular Alzak self-flanged reflector. (CP x .97)
- 69 Wheat specular Alzak self-flanged reflector. (CP x .97)
- 70 SofTex Clear softly etched self-flanged reflector. Resists smudges. (CP x .98)
- 71 SofTex Dune softly etched self-flanged reflector. Resists smudges. (CP x .95)
- 72 Black specular Alzak self-flanged reflector. (CP x .80)
- 79 Extension collar for up to 2" thick ceilings.
- 82 Sloped ceiling adapter. Specify slope in 5° increments up to 30°.
- 90 SofTex Champagne Gold softly etched self-flanged reflector. (CP x .96)
- 91 SofTex Wheat softly etched self-flanged reflector. (CP x .95)
- 93 Pewter specular Alzak self-flanged reflector. (CP x .95)
- 94 Specular or SofTex custom color / finish reflector, self-flanged. Consult factory.
- 99 Special modification. Consult factory.
- LP With PAR 38 lamp. Specify wattage, beam spread and color temperature.
- OG OptiGroove black seamless tapered aluminum reflector. White trim, self-flanged. (CP x .82)

SUBMITTAL DATA

APPROVAL STAMP

JOB NAME _____

TYPE _____

WATTAGE _____ VOLTAGE _____

CATALOG NUMBER _____

LIMITED WARRANTY: CATALOGUED KIRLIN FIXTURES ARE WARRANTED FREE OF DEFECTS IN WORKMANSHIP OR MATERIAL FOR THREE YEARS FROM DATE OF PURCHASE. INSTALLATION, ETC., IS NORMAL USE. Manufacturer at his option will replace or repair such fixture or refund the purchase price on presentation of proof of purchase and defective fixture at the office of manufacturer within the first year of original purchase. Liability of manufacturer is limited to the foregoing, and manufacturer shall not be liable for any other damages, direct or indirect, sustained or suffered by purchaser or any person. This warranty is supplied for the fixture in place of all other warranties, expressed or implied. Seller does not warrant as to merchantability or fitness for a particular use, nor liability or statement constitute a warranty or amend this specific warranty. Abnormal use, abuse of the fixture, improper installation, or repair, or modification of the fixture without prior written authorization from the manufacturer will void the warranty void.