

CATALOG #	TYPE	
JOB NAME	WATTAGE	VOLTAGE

9" 1 PAR38 250 WATT MAXIMUM

RR00936

MRI Open Eyeball Adjustable

Features

Lamp

- Designed for **non-magnetic** medium base lamp: 250 watt (max.) PAR 38 tungsten halogen (by others). Rated 4200 hour life.
- Dimmable (controls by others).
- For operation on D.C. circuits.

Non-Ferrous Socket

- Glazed porcelain medium base. Nickel plated brass screw shell. Silicone leads.

Trim

- White eyeball assembly rotates 358° with 40° maximum tilt. White smooth seamless self-flanged flare trim.
- Non-magnetic springs; snug fit to ceiling.

Housing

- Cool. Acrylic enameled 100% aluminum.
- Rustproof: Exceeds 1000 hour ASTM 5% salt spray test.
- Dissipates heat across entire surface area.

- Entire luminaire visible and serviceable from below through removable reflector.
- Built-in plaster frame. Also see Option -79.

Outlet Box

- Prewired. 100% aluminum. UL listed.
- Accessible. 1/2" and 3/4" knockouts.

Installation

- Lightweight. Recesses in any ceiling type.
- 27" aluminum hanger bars supplied (2).
- Fully adjustable universal non-magnetic mounting brackets supplied (2).

UL, C-UL (Canada) Listings

- Wet, damp or dry locations, covered ceilings.
- Through-branch circuit conductors (up to 6 #12). Supply wire rating: 90°C.

Three Year Limited Warranty

- Complete standard fixture.

Thermal Protection (Per Current NEC)

- Thermal protector included which provides automatic cut-off if rated temperature is exceeded. (Insulation related)

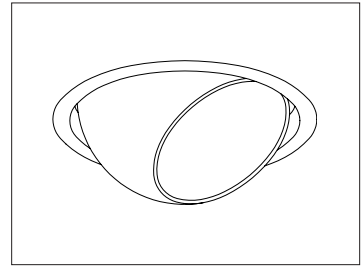

Recessed Round
Adjustable
Eyeball
MRI

NOT RESTRICTED TO END-OF-RUN USE

Performance at a Glance

RR00936

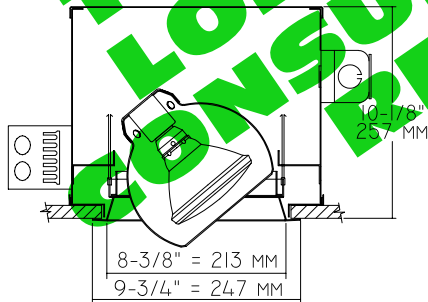

Ceiling Cut-out
9"

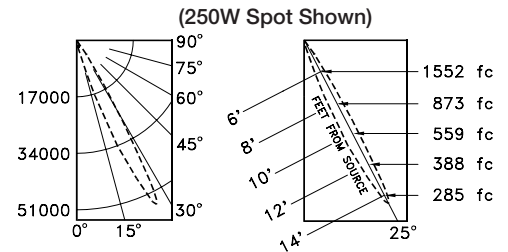
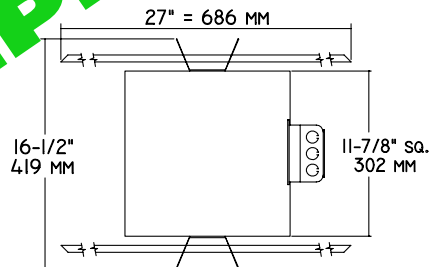

EFFICIENCY: 91.4%
(Data collected with lamp tilted at 25°)

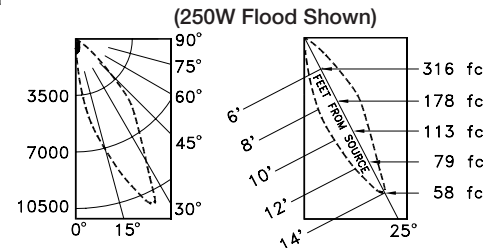

EFFICIENCY: 87.4%
(Data collected with lamp tilted at 25°)

THE KIRLIN COMPANY

3401 EAST JEFFERSON AVENUE • DETROIT, MICHIGAN 48207-4232
(313) 259-6400 • Fax: (313) 259-9409 OR (313) 259-3121 • www.kirlinlighting.com

HEALTHCARE FACILITY
& PATIENT LIGHTING

MAXIMUM WATTAGE

1 PAR38 250

CATALOG NUMBER

RR00936

DUE TO OUR CONTINUING EFFORT TO IMPROVE PRODUCTS, TECHNICAL INFORMATION IS SUBJECT TO CHANGE WITHOUT NOTICE.

Detailed Photometry - Installed Fixture

Photometry from I.T.L., Boulder, CO

RR00936 (250 Watt Spot)

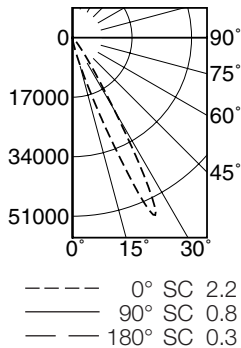

EFFICIENCY : 91.4%

CANDLEPOWER DISTRIBUTION					
	0.0	45.0	90.0	135.0	180.0
0	566	566	566	566	566
5	729	638	562	410	455
15	7469	1108	531	152	91
25	55899	972	273	76	61
35	6832	668	91	61	61
45	1063	562	61	61	30
55	668	288	61	46	30
65	213	76	61	30	0
75	61	61	30	0	0
85	61	61	0	0	0
90	61	46	0	0	0

Data collected with lamp tilted at 25°

COEFFICIENTS OF UTILIZATION							
RF	20						
	80			50			
RC	70	50	30	10	50	30	10
1	102	99	96	91	96	91	89
2	96	91	86	82	86	83	80
3	90	83	78	73	79	75	71
4	84	76	70	66	73	68	64
5	79	70	64	59	67	62	58
6	74	65	58	54	62	57	53
7	70	60	53	49	58	52	49
8	66	56	49	45	54	48	44
9	62	52	45	41	50	45	41
10	58	48	42	38	47	41	38

ITL TEST #46962

RR00936 (250 Watt Flood)

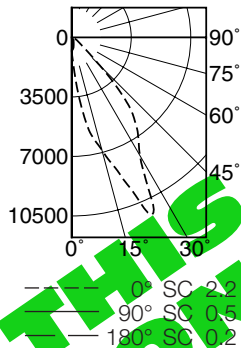

EFFICIENCY : 87.4%

CANDLEPOWER DISTRIBUTION					
	0.0	45.0	90.0	135.0	180.0
0	778	778	778	778	778
5	2346	1546	718	414	359
15	6845	3767	442	166	138
25	11371	3519	262	69	55
35	6762	1270	152	55	55
45	2374	469	69	55	55
55	552	290	55	55	28
65	248	110	55	28	0
75	83	55	41	0	0
85	55	55	0	0	0
90	55	41	0	0	0

Data collected with lamp tilted at 25°

COEFFICIENTS OF UTILIZATION							
RF	20						
	80			50			
RC	70	50	30	10	50	30	10
1	98	95	92	90	89	87	85
2	92	86	82	79	82	79	76
3	86	79	74	70	75	71	68
4	80	72	67	62	69	65	61
5	75	67	60	56	64	59	55
6	71	61	55	51	59	54	50
7	66	57	50	46	55	50	46
8	62	53	46	42	51	46	42
9	59	49	43	39	47	42	38
10	55	45	40	36	44	39	35

ITL TEST #46961

Options

- 32 Trim extender. Broadens trim flange O.D. by 1".
- 44 Black OptiGroove regressed trim assembly, white self-flanged, instead.
- 45 Gasket above reflector / trim flange.
- 94 Custom color. Specify parts. Consult factory.
- 99 Special modification. Consult factory.
- LP With PAR lamp. Specify wattage, style and beam spread.

SUBMITTAL DATA

APPROVAL STAMP

JOB NAME
TYPE
WATTAGE VOLTAGE
CATALOG NUMBER

LIMITED WARRANTY: CATALOGED KIRLIN FIXTURES ARE WARRANTED FREE OF DEFECTS IN WORKMANSHIP OR MATERIAL FOR THREE YEARS FROM DATE OF PURCHASE. INSTALLLED TO N.E.C. IN NORMAL USE. Manufacturer at the option will replace or repair such fixture or refund the purchase price on presentation of proof of purchase and defective fixture at the office of manufacturer within three years of original shipment. Liability of manufacturer is limited to the replacing, and manufacturer shall not be liable for any other damages, direct or indirect, sustained or suffered by purchaser or any person. This warranty is supplied to the buyer in place of all other warranties, expressed or implied. Seller does not warrant as to merchantability or fitness for a particular use, nor will any oral statement constitute a warranty or amend this specific warranty. Abnormal use, abuse of the fixture, improper installation, or repair, or modification of the fixture without prior written authorization from the manufacturer will render the warranty void.