

CATALOG #	TYPE	
JOB NAME	WATTAGE	VOLTAGE

# Latitudes Series

## Open Appearance 4" Downlight • LED

Up to 90,000 Hour Life • Type IC • Air Tight Optional  
Wet Listed • LM-79 Certified • LM-80 Qualified

# LRS-04042



## Specifications

### Delivered System Performance

- Nominal Lumens: **Must Specify**

#### Type IC

-2000L

-1500L

-1000L

- Select trim & beam distribution: see chart
- Select color (CCT): see chart; 80+ CRI standard; Option -HC for 90+ (15% lumen loss)
- 90,000 hour life (L70\*\*)

### Thermal Management System

- Aluminum heat sink and components for cool operation, long life, and low maintenance

### LED Driver - INTERNAL

- Indoor/Outdoor: -30°C to 60°C (-22°F to 140°F)
- 0-10V CCR 10% dimming standard
- 120-277V / 50-60 Hz standard; load insensitive

### Trim Assembly

- Low brightness clear aluminum self-flanged downlight square with lens above

### Acrylic Enameled Aluminum Housing

- Rustproof and corrosion resistant: exceeds 1000 hour ASTM 5% salt spray test
- Shallow depth fits restricted plenums
- Cool operation extends component life
- Modular design; visible and fully serviceable through aperture
- Built-in plaster flange

### Outlet Box (Galvanized)

- UL Listed, 14GA, insulated, removable cover
- ½" and ¾" knockouts

### Installation & Hardware

- Indoor/outdoor in ceilings up to 1¼" thick or see Option -79
- Compatible with fire rated enclosures (by others)
- 27" hanger bars & adjusting brackets (2) supplied

### UL, C-UL (Canada) Compliance

- Wet, damp or dry locations, covered ceilings
- Type IC for direct contact with insulation
- Through-branch conductors (4 #12 AWG 90°C) for Type IC Listing

### IEC & FCC Compliance

- Meets IEC/EN 60601-1-2 electromagnetic compatibility standard for medical electrical equipment
- FCC Part 15 certified for EMI/RFI emissions

### FIVE YEAR Limited Warranty

- Complete standard fixture



## Options and Ordering Configuration

(Example: LRS-04042-1500L-120-MFL-35K-37F-RH-AT)

Must Specify					Optional			
Model	Lumens	Volts	Beam	CCT† & CRI	Driver Options	Emergency Options	Trim Options	Other Options
LRS-04042	-2000L -1500L -1000L	-120 -277 -97†: Other Voltage	(Blank): MFL  -SPT -NFL -MFL	(Blank): 3500°K, 80+ CRI  <b>80+ CRI*</b> -27K: 2700°K -30K: 3000°K -35K: 3500°K -41K: 4100°K -50K: 5000°K  *Note: Lumen Factor = 0.93 for -27K  <b>90+ CRI**</b> -27K-HC: 2700°K -30K-HC: 3000°K -35K-HC: 3500°K -41K-HC: 4100°K -50K-HC: 5000°K  **Note: Lumen Factor = 0.79 for -27K-HC; All Others = 0.85; consult factory	(Blank): Standard 0-10V CCR 10% dim  -D1†: 0-10V 1.0% dim -D2†: 0-10V 0.1% dim -D3†: DALI 1.0% dim -D4†: DALI 100-0.1% dim -D5†: DMX512A 0.1% dim -D40: -40°C (-40°F) driver; 0-10V 10% dim	(Blank): None  -EI: Remote emergency inverter for 100% rated lumens; Run time: 90+ minutes; N/A for options -FS, -97  -EM: Internal emergency battery pack; Delivers 500 lumens; Run time: 90+ minutes  -ERH: Remote emergency battery pack; Delivers 1000 lumens; CEC Compliant; Run time: 90+ minutes	(Blank): Standard clear aluminum self-flanged downlight square with lens above  <b>Trim Finishes</b> -30: All white enameled trim -31: White acrylic enameled trim flange -37F: Dark bronze enamel flange -38F: Black enamel flange -70: Clear semi-specular SofTex™ trim -94: Custom color; consult factory  <b>Other Trim Features</b> -23: Frosted microprismatic lens -32: White trim extender, specify OD -33: Decorative Glow Ring; see last page for details -45: Gasket between trim & ceiling -CF: Custom color filter (Rosco); Specify -DF: Electrically isolated trim -WA: White acrylic lens; will produce wide flood distribution	(Blank): None  <b>Mounting</b> -79: Extension collar for ceilings up to 2" thick -RH: Joist mounting hardware instead  <b>Other Options</b> -99: Special modification; consult factory -AT: Air Tight version; Meets ASTM E283 airflow restriction of 2CFM max. Option -RH required -FS: Fused primary; One per fixture; N/A for option -EI
<b>Projected L70** for Kirlin Luminaires</b>								
In Open Plenum		90,000 hours						
In Insulation (Type IC)		70,000 hours						
**Hours at 70% lumen maintenance								
		†Consult factory						
					†Consult factory for use with -2000L			

## Performance Factors

NOMINAL LUMENS	LUMEN FACTOR	NOMINAL WATTS	LPW FACTOR
-2000L	1.257	29.0	0.92
-1500L	1.00	21.1	1.00
-1000L	0.579	10.4	1.17

## Dimensions

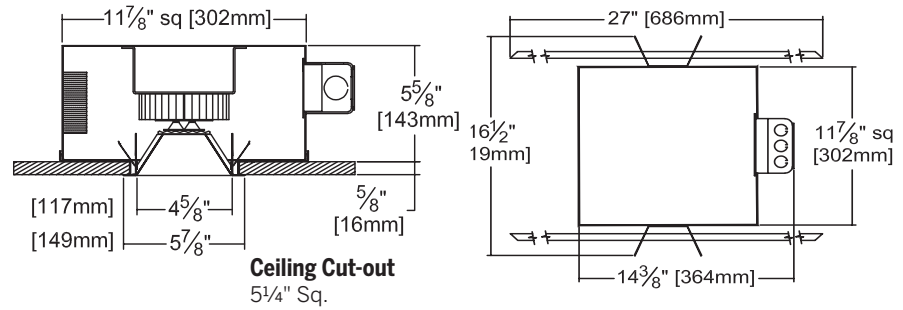

\* See notes on page 1 for additional info on Lumen Factors

## Photometry - Installed Complete Fixture

LM-79 IESNA Certified Photometry from Independent Lab

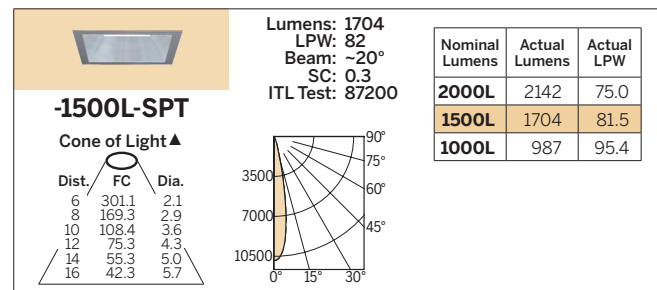
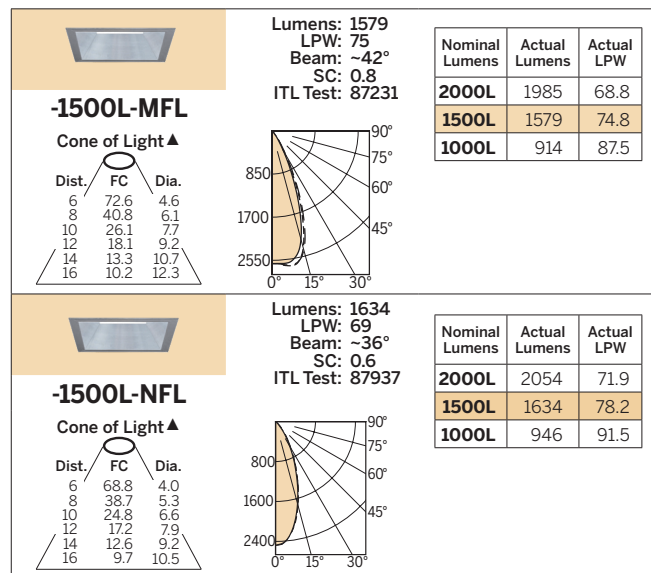

LED manufacturers maintain a tolerance of +/-7% on flux (lumens) and power (electrical) measurements.

▲ **Cone of Light Key**      **Dist.** Distance (Ft.) from fixture  
 Dia. (in ft.) shown is where FC      **FC** Footcandles at nadir (0°)  
 value is half the FC at nadir.      **Dia.** Circle of light at 50% of FC

# Classic Glow Rings: Option -33 for Latitudes

To order a Kirlin Glow Ring, begin by adding -33 to the product number. Then, configure your Glow Ring by selecting each of the 7 design elements listed below:

**(Example: LRS-04042-2000L-120-30K-NFL-33-GLM-1L-FRR-ROF-SIF-ROS-SIS)**

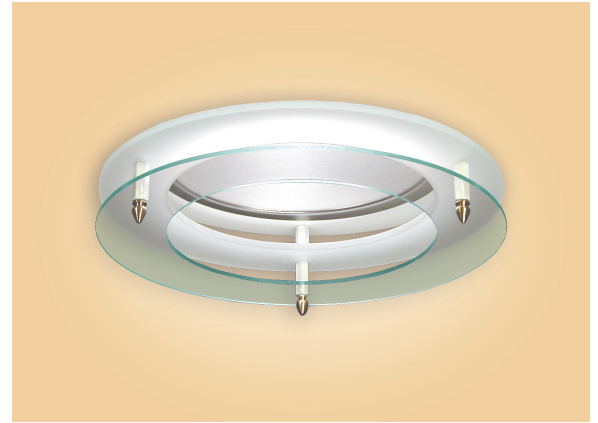

1. Ring Material  
(choose one)

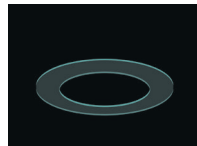

Glass (-GLM)



Acrylic (-ACM)



Custom (-CUM)

2. # of Rings  
(choose one)



1 Ring (1L)

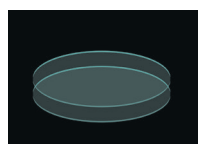

2 Rings (-2L)

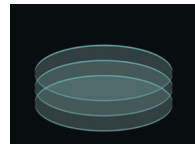

3 Rings (-3L)

3. Ring Design  
(choose one)



Frosted Ring (-FRR)



Clear Ring (-CRR)

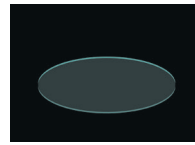

Solid Disk (-SDR)



Frosted Center (-FCR)



Frosted Disk (-FDR)

4. Finial Design  
(choose one)

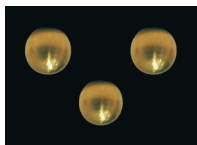

Round (-ROF)



Knurled (-KNF)

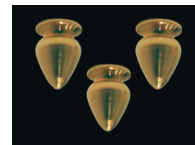

Cone (-COF)

5. Finial Color  
(choose one)



Brass (-BRF)



Silver (-SIF)

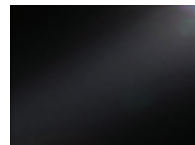

Black (-BLF)

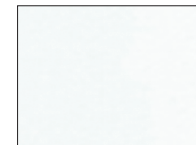

White (-WHF)



Custom (-CUF)

6. Standoff Design  
(choose one)

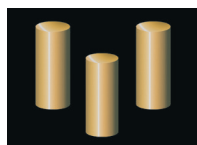

Round (-ROS)

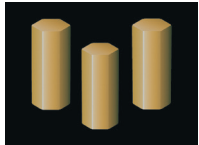

Hexagonal (-HOS)

7. Standoff Color  
(choose one)



Brass (-BRS)



Silver (-SIS)



Black (-BLS)



White (-WHS)



Custom (-CFS)