

CATALOG #	TYPE	
JOB NAME	WATTAGE	VOLTAGE

4" 4 LED 12 SYSTEM WATTS

LRR-04021

Open Appearance Adjustable • LED

50,000+ Hour Life • 82 CRI • 3 Distributions • Type IC

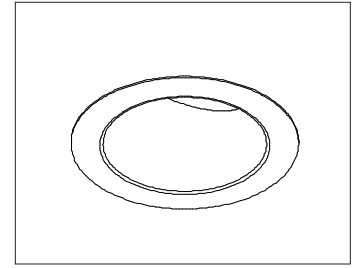

Specifications

LED Light Engine

- 12 watt LED array. 3500°K standard (or see Options -30K or -41K).
- 450* lumens, 38 lumens per watt (total system).
- 82 CRI, 50,000+ hour life.**
- Fully sustainable: removable for servicing.

Center Beam Optics

- Narrow flood (NFL) standard. Optional: spot (SPT) or medium flood (MFL).
- Self-aligns with trim for optimal performance.
- Hot aiming by hand or screwdriver.
- Tilts from 0° to 45° in 1° increments and locks in place.
- Rotates full 365° and locks in place.
- Accommodates sloped ceilings up to 45°

Thermal Management System

- All-aluminum proprietary heat sink, components and housing maximize luminaire's cool operation and long life while minimizing maintenance.

LED Power Supply

- Suitable for outdoor / indoor use: -30°C (-22°F) to 60°C (140°F).
- 120-277V / 50-60Hz standard. Load insensitive.
- Dimming available, see Option -39.
- Kirilin remote SmartSupply™ driver instead, see Option -SS.

Electrically Isolated Trim

- Specular clear aluminum self-flanged and gasketed angle cut cone with clear lens above.
- Non-conductive vinyl coated trim spring clips minimize risk of electric shock.
- Colors and specular finishes available.

Acrylic Enamelled Aluminum Housing

- Rustproof and corrosion resistant: Exceeds 1000 hour ASTM 5% salt spray test.
- Shallow depth fits restricted plenums.
- Cool operation: Extends life of all components.
- Fully sustainable: Entire luminaire, including LED light engine, easily visible and serviced through aperture.
- Built-in plaster flange.

- All-Tight design available, see Option -AT.
- **Outlet Box**
- UL listed J-box with insulated removable cover. Prewired 14 GA (NEC) with 1/2" and 3/4" knockouts.

Installation

- Recess indoor or outdoor.
- Accommodates ceilings up to 1-1/8" thick.
- 27" galvanized hanger bars with adjustable mounting brackets (2) supplied.
- For residential mounting hardware for wood joist ceilings, see Option -RH.

UL, C-UL (Canada) Listings

- Wet locations.
- Type IC: for direct contact with insulation.
- Through-branch conductors (4 #12 AWG 90°C) for Type IC Listing.



FIVE YEAR Limited Warranty

- Complete standard fixture.

Performance at a Glance

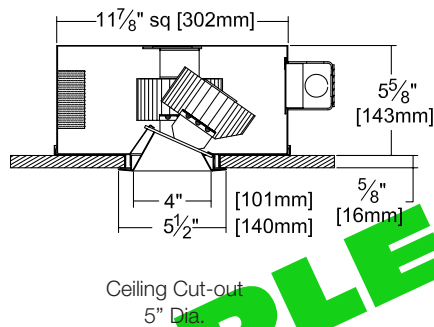

Standard (NFL)

	30°	45°
Lumens:	324	301
Efficiency:	77.7%	72.2%
Beam:	~31°	

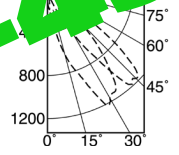

Option -SPT

	30°	45°
Lumens:	312	288
Efficiency:	74.8%	69.1%
Beam:	~16°	

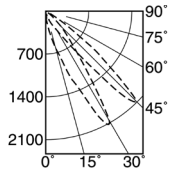

Option -MFL

	30°	45°
Lumens:	286	257
Efficiency:	68.6%	61.6%
Beam:	~49°	

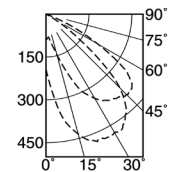

THE KIRLIN COMPANY

3401 EAST JEFFERSON AVENUE • DETROIT, MICHIGAN 48207-4232
(313) 259-6400 • Fax: (313) 259-9409 OR (313) 259-3121 • www.kirlinlighting.com

Photometry - Installed Fixture

Photometry from I.T.L., Boulder, CO
Photometric testing done in accordance with IESNA LM-79-08

- D: Distance (in feet) to floor or wall.
- FC: Max. footcandles on surface within effective visual beam. (Visual beam is 50% of max. FC.)
- L: Effective visual beam length in feet.
- W: Effective visual beam width (in feet).
- CB: Distance (in feet) to center beam.

LRR-04021 (NFL)

	30°	45°
Lumens:	324	301
Efficiency:	77.7%	72.2%
Beam:	~31°	

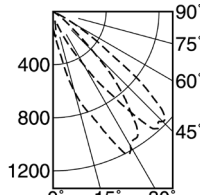

FC on Horizontal Plane

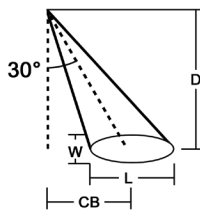

FC on Vertical Plane

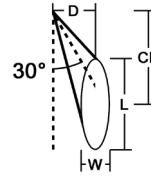

FC on Vertical Plane

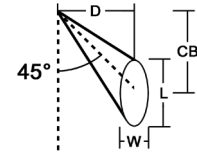

D	FC	L	W	CB
4.0	53	2.4	2.1	2.8
6.0	23	3.6	3.1	3.2
7.0	17	4.2	3.6	3.7
8.0	13	4.8	4.2	4.3
9.0	10	5.3	4.7	4.8
10.0	8	5.9	5.2	5.3
12.0	6	7.1	6.2	6.4
14.0	4	8.3	7.2	7.4

ITL TEST: #62229

D	FC	L	W	CB
2.0	55	2.1	1.6	3.8
3.0	24	3.2	2.4	5.6
4.0	14	4.3	3.2	7.5
5.0	9	5.3	3.9	9.4
6.0	6	6.3	4.7	11.3
8.0	3	8.5	6.3	15.0
10.0	2	10.6	7.9	18.8
12.0	2	12.7	9.8	22.6

ITL TEST: #62229

D	FC	L	W	CB
2.0	114	1.2	1.2	2.1
3.0	51	1.8	1.8	3.1
4.0	28	2.4	2.4	4.1
5.0	18	3.0	2.9	5.2
6.0	13	3.6	3.5	6.2
8.0	7	4.8	4.7	8.3
10.0	5	6.1	5.9	10.4
12.0	3	7.3	7.1	12.4

ITL TEST: #62232

LRR-04021 (Option -SPT)

	30°	45°
Lumens:	312	285
Efficiency:	74.8%	69.1%
Beam:	~16°	



D	FC	L	W	CB
4.0	86	1.5	1.3	2.2
6.0	38	2.1	1.9	3.3
7.0	28	2.6	2.2	3.9
8.0	22	3.0	2.5	4.4
9.0	17	3.4	2.8	5.0
10.0	14	3.7	3.1	5.6
12.0	10	4.5	3.6	6.7
14.0	7	5.2	4.1	7.8

ITL TEST: #62228

D	FC	L	W	CB
2.0	66	2.2	1.0	3.6
3.0	29	3.4	1.6	5.4
4.0	16	4.1	2.1	7.2
5.0	10	5.5	2.6	9.0
6.0	7	6.6	3.1	10.8
8.0	4	8.7	4.2	14.4
10.0	3	10.9	5.2	18.0
12.0	2	13.1	6.3	21.6

ITL TEST: #62228

D	FC	L	W	CB
2.0	183	0.9	0.8	2.0
3.0	82	1.3	1.1	3.1
4.0	46	1.8	1.5	4.1
5.0	29	2.2	1.9	5.1
6.0	20	2.7	2.3	6.1
8.0	11	3.5	3.0	8.1
10.0	7	4.4	3.8	10.2
12.0	5	5.3	4.5	12.2

ITL TEST: #62231

LRR-04021 (Option -MFL)

	30°	45°
Lumens:	286	257
Efficiency:	68.6%	61.6%
Beam:	~49°	

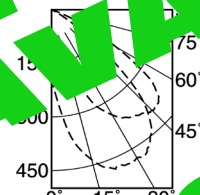

D	FC	L	W	CB
4.0	25	3.3	2.8	2.5
6.0	11	5.0	4.2	3.7
7.0	8	5.8	4.9	4.3
8.0	6	6.6	5.7	5.0
9.0	5	7.5	6.4	5.5
10.0	4	8.3	7.2	6.1
12.0	3	9.9	8.5	7.4
14.0	2	11.6	9.9	8.6

ITL TEST: #62230

D	FC	L	W	CB
2.0	32	1.9	1.9	3.3
3.0	13	2.9	2.8	4.9
4.0	8	3.9	3.7	6.5
5.0	5	4.8	4.6	8.2
6.0	4	5.8	5.4	9.8
8.0	2	7.7	7.4	13.1
10.0	1	9.6	9.3	16.9
12.0	1	11.6	11.1	19.6

ITL TEST: #62230

D	FC	L	W	CB
2.0	46	1.5	1.6	2.1
3.0	20	2.3	2.4	3.1
4.0	12	3.0	3.2	4.1
5.0	7	3.8	4.0	5.2
6.0	5	4.5	4.7	6.2
8.0	3	6.0	6.3	8.3
10.0	2	7.6	7.9	10.4
12.0	1	9.1	9.5	12.4

ITL TEST: #62233

* LED manufacturers maintain a tolerance of ±7% on flux (lumens) and power (electrical) measurements. Kirlin photometrics are actual test data from Independent Testing Laboratories (ITL) where photometry was measured from 420 lumen light engine (within the established tolerance).

** LED Operating Characteristics: 50,000 hours at 70% lumen maintenance.

Options

LED Power Supply

- 39 Dimmable power supply, 0-10V analog standard. Specify voltage. Consult factory for brand availability and pricing.
- 97 Specify other voltage. Consult factory.
- SS Remote mounted Kirlin SmartSupply™ driver, sold separately. Drives up to 12 fixtures at 20W each. Order LPS-1220A (0-10V analog dimming) or LPS-1220D (DMX dimming). See kirlinlighting.com or CF for more information.

Optics

- MFL Medium flood. (~49° distribution)
- SPT Spot. (~16° distribution)

Trims

- 30 All white acrylic enameled cone. (CP x .95)
- 31 White acrylic enameled cone flange.

- 32 White oversize trim ring. Specify O.D.
- 46 Gasket between trim and lens.
- 59 Dark Bronze specular self-flanged cone. (CP x .80)
- 60 Softex Dark Bronze self-flanged cone. (CP x .75)
- 63 Dune specular self-flanged cone. (CP x .93)
- 68 Matte black self-flanged cone. (CP x .70)
- 69 Wheat specular self-flanged cone. (CP x .92)
- 70 Softex Clear self-flanged cone. (CP x .93)
- 71 Softex Dune self-flanged cone. (CP x .89)
- 72 Black specular self-flanged cone. (CP x .80)
- 77 Softex Pewter self-flanged cone. (CP x .85)
- 91 Softex Wheat self-flanged cone. (CP x .88)
- 93 Pewter specular self-flanged cone. (CP x .88)
- 94 Custom color/finish. Specify. Consult factory.

Filter

- AM Amber filter.
- DP Dichroic Peach filter.
- GE Green / Botanical filter.

- HX Hexcel louver.
- MB Medium Blue filter.
- PK Pink / Rose filter.
- XF Custom filter other than shown. Specify.

Other

- 99 Special modification. Consult factory.
- AT Air tight version. Meets ASTM E283 restricted airflow of 2 CFM maximum.
- DL Downlight cone instead. Clear specular finish standard or add optional trim selection.
- 30K Color temperature 3000°K instead.
- 41K Color temperature 4100°K. Consult factory.
- RH Residential mounting hardware instead. Suitable for wood joist ceilings with spacing from 14 1/8" to 25 1/8" with 5/8" vertical adjustability.

SUBMITTAL DATA

JOB NAME _____
 TYPE _____
 WATTAGE _____ VOLTAGE _____
 CATALOG NUMBER _____

APPROVAL STAMP

LIMITED WARRANTY: CATALOGED KIRLIN FIXTURES ARE WARRANTED FREE OF DEFECTS IN WORKMANSHIP OR MATERIAL FOR THREE YEARS FROM DATE OF PURCHASE. INSTALL TO N.E.C. IN NORMAL USE. Manufacturer of the fixture will replace or repair such fixture or refund the purchase price on presentation of proof of purchase and defective fixture at the offices of manufacturer within three years of original shipment. Liability of manufacturer is limited to the foregoing and manufacturer shall not be liable for any other damages, direct or indirect, sustained or suffered by purchaser or any person. This warranty is supplied to the buyer in place of all other warranties, expressed or implied. Seller does not warrant as to merchantability or fitness for a particular use, nor will any oral statement constitute a warranty or amend this specific warranty. Abnormal use, abuse of the fixture, improper installation, or repair or modification of the fixture without prior written authorization from the manufacturer will render the warranty void.