

CATALOG #	TYPE	
JOB NAME	WATTAGE	VOLTAGE

Retrofit Series

Nightlight Upgrade Kit (With Faceplate) • LED

For Existing Kirlin Luminaires • Type IC

LKN-07101



Specifications

LED

- White module, mounted to front of specular reflector (color filters optional)
- 5.5 system watts - energy efficient, uniform, cool
- 68 lumens standard; 125 lumens with Option -HW

LED Power Supply/Driver

- Max 13 volt DC and 4 watt fixed output; electronically stabilized Mounted internally to specular reflector
- Minimum operating temperature -4°F (-20°C)
- 120-277 volt standard; load insensitive

Lens Behind Louver

- Diffuse acrylic lens behind louver. Also see Options

Faceplate Assembly

- Beveled and gasketed cast aluminum frame pulls tight to wall
- Die-formed and louvered aluminum door bolts tightly to frame with two flush mounted screws. See Option -17 for lens instead of louver
- Double gasketing between louver and frame, plus between frame and wall
- White finish standard; optional colors
- Optional (white only) antimicrobial Kirlin BioGard™ finish; see Option -BG
- Tamper resistant available; see Option -26
- Optional hospital grade duplex receptacle, GFCI and push button on-off switch available; rated 120V only; must add Option -120

Installation

- Inserts into existing Kirlin Nightlight housing
- Installs on two mounting pins in original fixture back box

UL, C-UL (Canada) Listings

- Type IC, damp or dry locations, covered ceilings, for use in Kirlin nightlights (UL Listed)

IEC & FCC Compliance

- Meets IEC/EN 60601-1-2 electromagnetic compatibility standard for medical electrical equipment
- FCC Part 15 certified for EMI/RFI emissions

FIVE YEAR Limited Warranty

- Complete standard fixture

Options and Ordering Configuration

(Example: LKN-07101-BL-37-26)

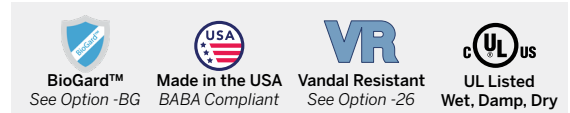

Required	Optional				
Model	Voltage/Lumens	Filter Colors	Lens and Trim	Faceplate Finishes	Other Options
LKN-07101	(Blank): 120-277 V	(Blank): None	(Blank): None	(Blank): Standard white finish	(Blank): None
	-120: 120V (50-60Hz) input; required for Options -34, -GF or -HD -HW: Higher light output; approximately doubles light output and system watts	-BL: Blue filter -GE: Green filter -OR: Orange filter -RA: Red/Amber filter -YE: Yellow filter -CF: Custom color filter (Rosco); specify	-17: .220" polycarbonate and white acrylic behind diffusion layer, with door instead of louvers; not available with Option -PC -34 With hospital grade push button on-off switch; indoor use; rated 120V only; must add Option -120; not available with Option -PC -CP: Clear polycarbonate lens instead of louver. Also see Option -26 -GF: With hospital grade duplex GFCI installed; indoor use; rated 120V only; must add Option -120; not available with Option -PC or -WL -HD: With hospital grade duplex receptacle installed; indoor use; rated 120V only; must add Option -120; not available with Option -PC or -WL	-35: Silver (natural aluminum) acrylic enamel -37: Dark bronze acrylic enamel -38: Black acrylic enamel -BG: BioGard™ anti-microbial white -BKBG: BioGard™ anti-microbial black -94: Custom color; consult factory -94BG: BioGard™ anti-microbial custom color finish	-26: Faceplate secured to housing with two center pin tamperproof screws; tamperproof tool included -99: Special modification; consult factory -PC: Photocell; nightlight will illuminate when room is dark; not available with Option -17 lens or switch and receptacle options

Dimensions

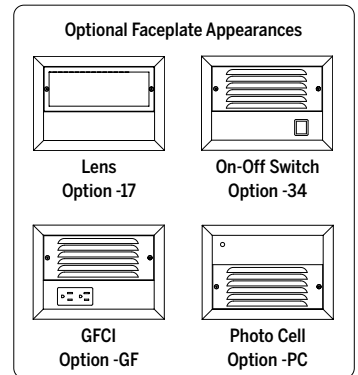
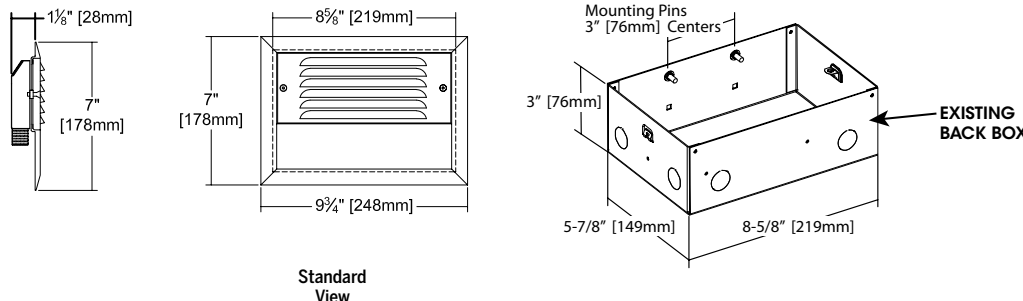

Performance

Footcandle Performance On the Floor - Top View
Photometry from I.T.L., Boulder, CO

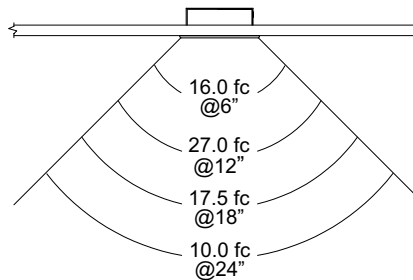
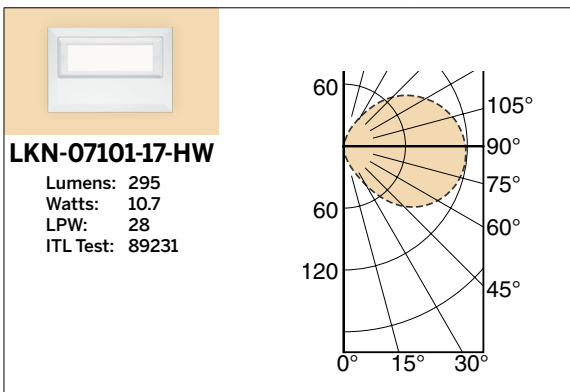
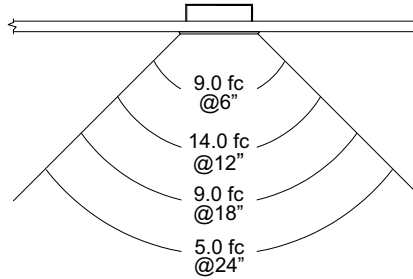
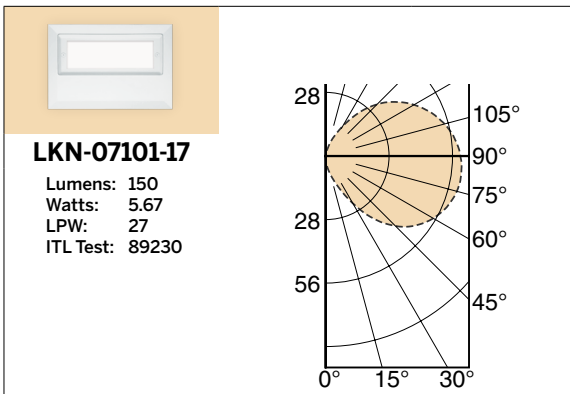
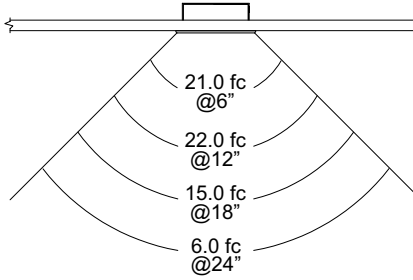
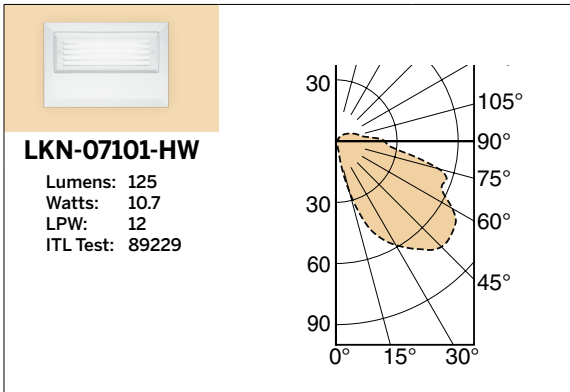
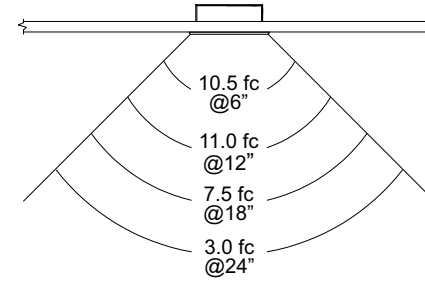
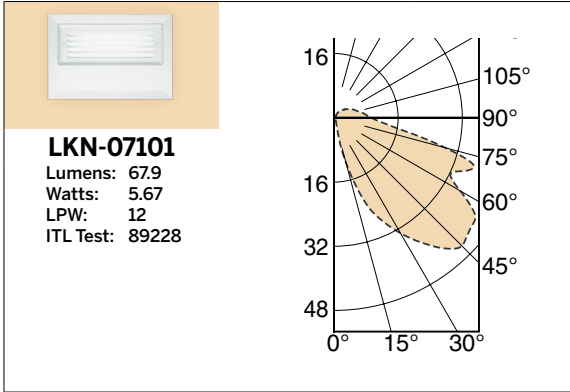

LIMITED WARRANTY: CATALOGED KIRLIN FIXTURES ARE WARRANTED FREE OF DEFECTS IN WORKMANSHIP OR MATERIAL FOR FIVE YEARS FROM DATE OF PURCHASE. INSTALLATION, IN-NORMAL USE, MANUFACTURER AT HIS OPTION WILL REPLACE OR REPAIR SUCH FIXTURE OR RETURN THE PURCHASER TO THE DATE OF PURCHASE AND DEDUCTIVE FROM THE ORIGINAL PURCHASE PRICE. THIS WARRANTY IS LIMITED TO THE ORIGINAL PURCHASER AND DOES NOT COVER DAMAGE TO THE FIXTURE CAUSED BY IMPROPER INSTALLATION, MISUSE, OR ABUSE. THIS WARRANTY IS VOID IF THE FIXTURE IS NOT INSTALLED OR USED IN ACCORDANCE WITH THE INSTALLATION INSTRUCTIONS. THIS WARRANTY IS APPLIED TO THE BUYER IN PLACE OF ALL OTHER WARRANTIES, EXPRESSED OR IMPLIED. SELLER DOES NOT WARRANT AS TO MERCHANTABILITY OR FITNESS FOR A PARTICULAR USE. NO OTHER STATEMENT CONSTITUTE A WARRANTY, ABNORMAL USE, ABUSE OF THE FIXTURE, IMPROPER INSTALLATION, OR REPAIR OR MODIFICATION OF THE FIXTURE WITHOUT PRIOR WRITTEN AUTHORIZATION FROM THE MANUFACTURER WILL RENDER THE WARRANTY VOID.

RETROFIT
 NOVEMBER 2024