

CATALOG #	TYPE	
JOB NAME	WATTAGE	VOLTAGE

15" 1 PAR 56 500 WATT MAXIMUM

ISR-15112

## PAR 56 Adjustable Cylinder

### Specifications

#### Lamp / Socket Assembly

- Designed for 1 vertical tungsten halogen lamp (by others):  
500W maximum PAR 56.
- Rated 4000 hour life; 100 CRI.
- Dimmable (controls by others).
- Tilts 150° for relamping.
- Safety tempered clear flat glass provided.
- Optional safety tempered prismatic C#73 flat glass converts oval beam pattern to round.
- See Option -15 for use with medium flood lamp.
- Porcelain mogul end-prong vertical socket.

#### Reflector

- Self-flanged parabolic specular Alzak® aluminum.
- Optional finishes and colors available.

#### Aluminum Housing

- Seamless white acrylic enameled. Rustproof: Exceeds 1000 hour ASTM 5% salt spray test.
- No visible cylinder hardware.
- Lightweight: Minimizes ceiling load.
- Cool operation: Extends component life.

#### Installation

- Center point mounting for snug fit to ceiling. Mounting hardware included.
- 2" collar for surface J-box mount, Option -80.
- Pendant or wall bracket mount available.
- Indoor or outdoor for covered ceiling use. For wet label in uncovered areas, add Option -89.

#### UL, C-UL (Canada) Listings

- Wet, damp or dry locations, covered ceilings.
- With Option -89: Wet, damp or dry locations, uncovered areas.
- 90°C minimum supply wire.

#### Three Year Limited Warranty

- Complete standard fixture.

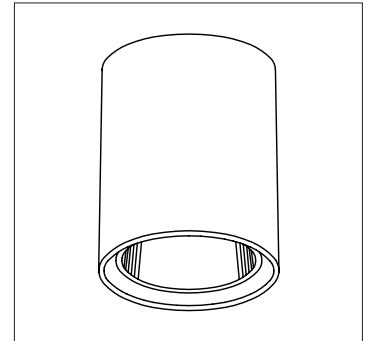

### Performance at a Glance

ISR-15112

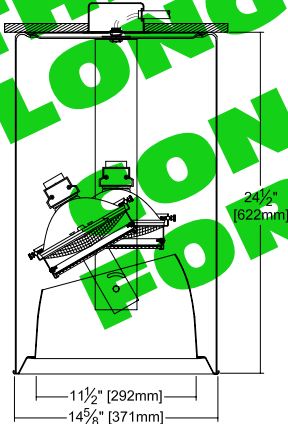

ISR-15112 (500W Narrow Spot)

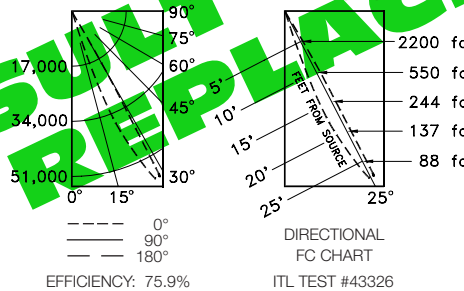

ISR-15112-15 (500W Medium Flood)

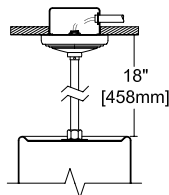
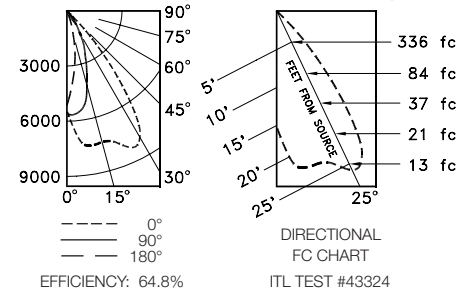

Representative Views:

(Left) With optional pendant mount (Option -PM)

(Right) With optional wall bracket (Option -WB)

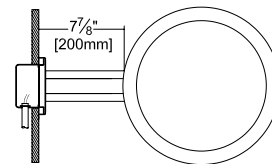

**Exceptional Energy Efficiency**

PHOTOMETRIC DATA SHOWN AT 25° TILT

## THE KIRLIN COMPANY

3401 EAST JEFFERSON AVENUE • DETROIT, MICHIGAN 48207-4232  
(313) 259-6400 • Fax: (313) 259-9409 OR (313) 259-3121 • www.kirlinlighting.com

TUNGSTEN HALOGEN &  
INCANDESCENT LIGHTING

MAXIMUM WATTAGE

500

CATALOG NUMBER

ISR-15112

DUE TO OUR CONTINUING EFFORT TO IMPROVE PRODUCTS, TECHNICAL INFORMATION IS SUBJECT TO CHANGE WITHOUT NOTICE.

Detailed Photometry - Installed Fixture

Photometry from I.T.L., Boulder, CO

ISR-15112 (500W Narrow Spot)

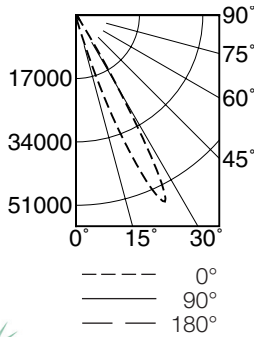

EFFICIENCY : 75.9%

CANDLEPOWER DISTRIBUTION					
	0.0	45.0	90.0	135.0	180.0
0	920	920	920	920	920
5	1041	1020	968	916	812
15	4476	1988	1072	833	770
25	55025	18571	1114	802	83
35	2290	3737	2186	1530	708
45	104	62	42	42	62
55	21	19	19	19	19
65	0	0	0	0	0
75	0	0	0	0	0
85	0	0	0	0	0
90	0	0	0	0	0

COEFFICIENTS OF UTILIZATION							
RF	20						
RC	80			50			
RW	70	50	30	10	50	30	10
1	86	84	82	80	79	78	76
2	81	77	74	71	74	71	69
3	77	72	68	64	69	65	63
4	72	66	62	58	64	60	57
5	68	61	57	53	59	55	52
6	64	57	52	48	55	51	48
7	60	53	48	44	51	47	44
8	57	49	44	41	48	43	40
9	54	46	41	37	44	40	37
10	50	42	37	34	41	37	34

ITL TEST #43326

ISR-15112 (500W Medium Flood)

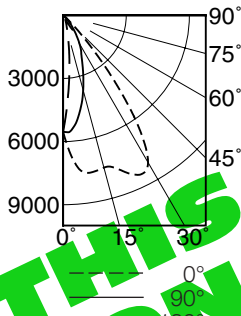

EFFICIENCY : 64.8%

CANDLEPOWER DISTRIBUTION					
	0.0	45.0	90.0	135.0	180.0
0	5537	5537	5537	5537	5537
5	7143	6974	6328	5375	3213
15	7495	6732	5270	3683	764
25	8366	5929	3401	2055	260
35	5880	4348	1708	1008	938
45	813	907	344	288	383
55	60	70	61	66	69
65	0	3	5	8	0
75	0	1	3	3	0
85	0	0	1	1	0
90	0	0	0	0	0

COEFFICIENTS OF UTILIZATION							
RF	20						
RC	80			50			
RW	70	50	30	10	50	30	10
1	73	72	70	68	68	66	65
2	70	66	64	61	63	61	59
3	66	62	58	56	59	56	54
4	62	57	54	51	55	52	50
5	59	53	49	47	52	48	46
6	56	50	46	43	48	45	43
7	53	47	43	40	45	42	39
8	50	44	40	37	43	39	37
9	48	41	37	35	40	37	34
10	45	39	35	32	38	35	32

ITL TEST #43324

Options

Lenses and Trims

- 15 Safety tempered prismatic C#73 flat glass. Use with MFL lamp. See -LP.
- 16 Champagne Gold specular Alzak reflector. (CP x .98)
- 30 All white reflector. (CP x .98)
- 31 White flange (only) on self-flanged reflector.
- 63 Dune specular Alzak reflector. (CP x .97)
- 69 Wheat specular Alzak reflector. (CP x .97)
- 70 SofTex clear reflector. (CP x .98)
- 71 SofTex Dune reflector. (CP x .95)
- 72 Black specular Alzak reflector. (CP x .80)
- 91 SofTex Wheat reflector. (CP x .95)
- 93 Pewter specular Alzak reflector. (CP x .95)
- 94 Custom color/finish. Specify. Consult factory.

- OG OptiGroove black seamless tapered aluminum reflector. White trim, self-flanged. (CP x .82)

Luminaire (Housing) Finishes

- 35 Natural aluminum acrylic enamel.
- 36 Gold acrylic enamel.
- 37 Dark Bronze acrylic enamel.
- 38 Black acrylic enamel.
- 94 Custom color/finish. Specify. Consult factory.

Mounting

- 54 Safety cable through pendant stem and 12" beyond. Use with -PM.
- 80 2" collar for mounting beneath surface outlet box. 1/2" T.S. KO's.
- 87 Custom pendant / wall bracket length. Specify. (Pendant length up to 4' or consult factory.) Use with Options -PM or -WB.

- 88 Swivel canopy for sloped ceilings up to 40°. Earthquake rated. Use with -PM.
- 89 Sealed top WeatherCap. Must add to Options -PM and -WB for wet label listing.
- PM Pendant mount. 3/8" T.S. x 18" stem or see Option -87. Must add Option -89 for wet label.
- WB Wall bracket mount. Must add Option -89 for wet label listing.

Other

- 99 Special modification. Consult factory.
- LP With PAR 56 lamp. Specify wattage and beam spread. With MFL, also select Option -15.

SUBMITTAL DATA

APPROVAL STAMP

JOB NAME

TYPE

WATTAGE

VOLTAGE

CATALOG NUMBER

LIMITED WARRANTY: KIRLIN FIXTURES ARE WARRANTED FREE OF DEFECTS IN WORKMANSHIP OR MATERIAL FOR THREE YEARS FROM DATE OF PURCHASE. INSTALLER TO N.E.C. IN NORMAL USE. Manufacturer of the fixture will replace or repair such fixture or refund the purchase price on presentation of proof of purchase and defective fixture at the office of manufacturer within three years of original shipment. Liability of manufacturer is limited to the foregoing and manufacturer shall not be liable for any other damages, direct or indirect, sustained or suffered by purchaser or any person. This warranty is subject to the buyer in place of all other warranties, expressed or implied. Seller does not warrant as to merchantability or fitness for a particular use, nor will any oral statement constitute a warranty or amend this specific warranty. Abnormal use, abuse of the fixture, improper installation, or repair, or modification of the fixture without prior written authorization from the manufacturer will render the warranty void.