

|           |         |         |
|-----------|---------|---------|
| CATALOG # | TYPE    |         |
| JOB NAME  | WATTAGE | VOLTAGE |

4" 1 MR16 50 WATT MAXIMUM **Type IC - IRS-04032**

## Open Appearance Lensed Shower Downlight • Square • Low Voltage

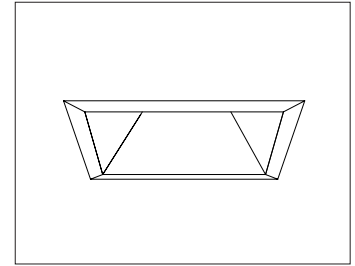

### Specifications

#### Lamp and Optional Filter Holder

- Designed for one 12 volt MR16 lamp (by others): 50 watt maximum.
- For filter holder and up to 2 filters, see Options.

#### Lampholder

- Heat resistant GX5.3 base porcelain socket.
- 300°C rated double wipe nickel plated contacts provide secure fit and optimal conductivity.
- Securely mounted within aluminum heat sink: protects lamp base, maintains secure fit.
- Insulated lead wires suitable for 250°C operation.

#### Lamp Module

- All aluminum for maximum heat dissipation and cool operation of entire lamp-socket-trim module.

#### WhisperPack™ Encapsulated Transformer

- Exclusive WhisperPack™ isolates and envelops transformer with proprietary heat and sound absorbing material.
- Provides longer life and cooler, quieter

operation. Easily accessible through ceiling aperture.

- Electronic dimmable stepdown (120V/12V) 90°C AC transformer. See Options for magnetic or toroidal versions and for 277 volt operation.

#### Electrically Isolated Trim

- Specular, clear aluminum self-flanged, gasketed downlight square with tempered microprismatic lens on top. Optional lenses, SofTex finishes, colors and white flange versions available.
- Non-conductive vinyl coated trim spring clips minimize risk of electric shock.

#### Acrylic Enameled Aluminum Housing

- Rustproof and corrosion resistant: Exceeds 1000 hour ASTM 5% salt spray test.
- Dual housing design includes air chamber for maximum heat dissipation.
- Cool operation: Extends life of all components.
- Entire luminaire easily serviced through aperture.
- Built-in plaster flange.
- For Air Tight or Top Access, see Options.

#### Outlet Box and Thermal Protection

- UL listed J-box with insulated removable

- cover. Prewired 14GA (NEC) with 1/2" and 3/4" knockouts.
- Thermal protector (per current NEC) provides automatic cut-off if rated wattage is exceeded.

#### Installation

- Recesses indoor or outdoor in covered locations.
- Accommodates ceilings up to 1 1/4" thick.
- Hardware provided suitable for grid or wood joist ceilings with spacing from 14 1/8" to 25 7/8" with 5/8" vertical adjustability.
- For adjustable version see IRS-04042.

#### UL, C-UL (Canada) Listings

- Wet, damp or dry locations, covered ceilings.
- Type IC. Approved for direct contact with insulation.
- Through-branch conductors (4 #12 AWG 90°C).

#### Three Year Limited Warranty

- Complete standard fixture.

### Performance at a Glance

IRS-04032: Type IC

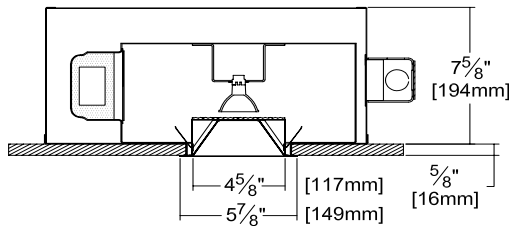

Ceiling Cut-out  
5" Dia.

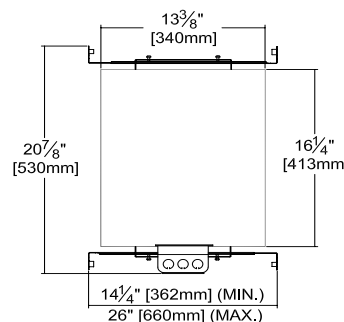

IRS-04032  
(50 Watt FL35)

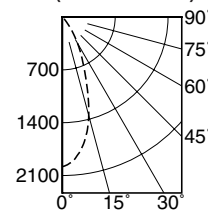

SC = 0.6  
EFFICIENCY: 76.4%  
ITL TEST #58978

IRS-04032  
(50 Watt VWFL60)

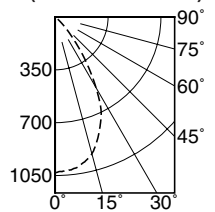

SC = 1.0  
EFFICIENCY: 73.8%  
ITL TEST #58984



**Exceptional  
Energy  
Efficiency**

For adjustable version see IRS-04042

## THE KIRLIN COMPANY

3401 EAST JEFFERSON AVENUE • DETROIT, MICHIGAN 48207-4232  
(313) 259-6400 • Fax: (313) 259-9409 OR (313) 259-3121 • www.kirlinlighting.com

**LOW VOLTAGE TUNGSTEN  
HALOGEN LIGHTING**

MAXIMUM WATTAGE

50

CATALOG NUMBER

IRS-04032

DUE TO OUR CONTINUING EFFORT TO IMPROVE PRODUCTS, TECHNICAL INFORMATION IS SUBJECT TO CHANGE WITHOUT NOTICE.

**Detailed Photometry - Installed Fixture**

Photometry from I.T.L., Boulder, CO

- D: Distance (in feet) to floor or wall.
- FC: Max. footcandles on surface within effective visual beam. (Visual beam is 50% of max. FC.)
- L: Effective visual beam length in feet.
- W: Effective visual beam width (in feet).

FC on Horizontal Plane

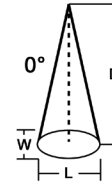

Lamp Angle

**IRS-04032 (50 Watt)**

LAMP: OSRAM SYLVANIA  
50MR16/IR/FL35/C  
TRIM: Open Appearance  
Shower  
EFFIC: 76.4%  
SC: 0.6

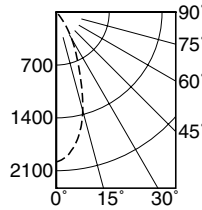

| D    | FC  | L   | W   |
|------|-----|-----|-----|
| 4.0  | 124 | 2.5 | 2.5 |
| 6.0  | 55  | 3.8 | 3.8 |
| 7.0  | 40  | 4.4 | 4.4 |
| 8.0  | 31  | 5.1 | 5.1 |
| 9.0  | 24  | 5.7 | 5.7 |
| 10.0 | 20  | 6.3 | 6.4 |
| 12.0 | 14  | 7.6 | 7.6 |
| 14.0 | 10  | 8.9 | 8.9 |

ITL TEST: #58978

LAMP: OSRAM SYLVANIA  
50MR16/IR/VWFL60/C  
TRIM: Open Appearance  
Shower  
EFFIC: 73.8%  
SC: 1.0

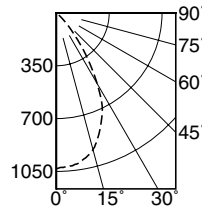

| D    | FC | L    | W    |
|------|----|------|------|
| 4.0  | 64 | 4.0  | 3.9  |
| 6.0  | 29 | 6.0  | 5.8  |
| 7.0  | 21 | 7.0  | 6.8  |
| 8.0  | 16 | 8.1  | 7.8  |
| 9.0  | 13 | 9.1  | 8.7  |
| 10.0 | 10 | 10.1 | 9.7  |
| 12.0 | 7  | 12.1 | 11.6 |
| 14.0 | 5  | 14.1 | 13.6 |

ITL TEST: #58984

**Options**

**Transformer, Wattage and Voltage**

- 58 For 277 volt line input.
- MG Magnetic (conventional) transformer instead.
- TD Toroidal magnetic transformer instead.

**Lenses - Mounted Above Trim**

- 15 C#73 prismatic tempered spread lens.
- 28 UV absorbing clear tempered lens.
- FP Frosted prismatic tempered lens

**Trims**

- 30 All white acrylic enameled finish.
- 31 White acrylic enameled trim flange.
- 32 White oversize trim extender. Specify size.
- 46 Gasket between trim and lens.
- 59 Dark Bronze specular self-flanged trim.

- 60 SofTex Dark Bronze self-flanged trim.
- 63 Dune specular self-flanged trim.
- 69 Wheat specular self-flanged trim.
- 70 SofTex Clear self-flanged trim.
- 71 SofTex Dune self-flanged trim.
- 72 Black specular self-flanged trim.
- 77 SofTex Pewter self-flanged trim.
- 79 Collar for ceilings up to 2 5/8" or consult factory.
- 91 SofTex Wheat self-flanged trim.
- 93 Pewter specular self-flanged trim.
- 94 Custom color/finish. Specify. Consult factory.

**Filter Holder / Filters (Specify 1 or 2)**

- FL Filter holder with up to two filter capacity.
- AM Amber filter.
- CL Clear tempered glass filter.
- DP Dichroic Peach filter.

- GE Green / Botanical filter.
- HX Hexcel louver.
- LN Linear glass filter.
- MB Medium Blue filter.
- MP Softening micropismatic filter.
- PF Crystal prismatic filter.
- PK Pink / Rose filter.
- UF Ultraviolet filter.
- XF Filter other than shown. Specify make/model.

**Other**

- 99 Special modification. Consult factory.
- AT Air tight version. Exceeds ASTM E283 restricted airflow of 2 CFM maximum.

**SUBMITTAL DATA**

JOB NAME \_\_\_\_\_  
TYPE \_\_\_\_\_  
WATTAGE \_\_\_\_\_ VOLTAGE \_\_\_\_\_  
CATALOG NUMBER \_\_\_\_\_

**APPROVAL STAMP**

LIMITED WARRANTY: CATALOGUED KIRLIN FIXTURES ARE WARRANTED FREE OF DEFECTS IN WORKMANSHIP OR MATERIAL FOR THREE YEARS FROM DATE OF PURCHASE. INSTALLATION TO N.E.C. IS NORMAL USE. Manufacturer of the option will replace or repair such fixture or refund the purchase price on presentation of proof of purchase and defective fixture at the office of manufacturer within three years of original shipment. Liability of manufacturer is limited to the foregoing, and manufacturer shall not be liable for any other damages, direct or indirect, sustained or suffered by purchaser or suffered by any person. This warranty is subject to the buyer in place of all other warranties, expressed or implied. Seller does not warrant as to merchantability or fitness for a particular use, nor will any oral statement constitute a warranty or amend this specific warranty. Abnormal use, abuse of the fixture, improper installation, or repair or modification of the fixture without prior written authorization from the manufacturer will render the warranty void.