

CATALOG #	TYPE	
JOB NAME	WATTAGE	VOLTAGE

4" 1 MR16 50 WATT MAXIMUM Type IC - IRS-04028

## Open 2" Pin Hole Downlight Square • Low Voltage

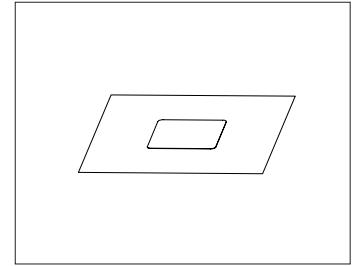

### Specifications

#### Lamp and Filter Holder

- Designed for one 12 volt MR16 lamp (by others): 50 watt maximum.
- Filter holder with clear tempered glass included. See Options for additional filters (2 filter capacity).

#### Lampholder

- Heat resistant GX5.3 base porcelain socket.
- 300°C rated double wipe nickel plated contacts provide secure fit and optimal conductivity.
- Securely mounted within aluminum heat sink: protects lamp base, maintains secure fit.
- Insulated lead wires suitable for 250°C operation.

#### Lamp Module

- All aluminum for maximum heat dissipation and cool operation of entire lamp-socket-trim module.

#### WhisperPack™ Encapsulated Transformer

- Exclusive WhisperPack™ isolates and envelops transformer with proprietary heat and sound absorbing material.

- Provides longer life and cooler, quieter operation. Easily accessible through ceiling aperture.
- Electronic dimmable stepdown (120V/12V) 90°C AC transformer. See Options for magnetic or toroidal versions and for 277 volt operation.

#### Pin Hole Trim

- White die cast square flat aluminum. Low brightness black inner bevel and cone. Optional trim colors and finishes available.

#### Acrylic Enamelled Aluminum Housing

- Rustproof and corrosion resistant: Exceeds 1000 hour ASTM 5% salt spray test.
- Dual housing design includes air chamber for maximum heat dissipation.
- Cool operation: Extends life of all components.
- Entire luminaire easily serviced through aperture.

- Built-in plaster flange.

- For Air Tight or Top Access, see Options.

#### Outlet Box and Thermal Protection

- UL listed J-box with insulated removable cover. Prewired 14GA (NEC) with 1/2" and 3/4" knockouts.
- Thermal protector (per current NEC) provides

automatic cut-off if rated wattage is exceeded.

#### Installation

- Recesses indoor or outdoor in covered locations.
- Accommodates ceilings up to 1 1/4" thick.
- Hardware provided suitable for grid or wood joist ceilings with spacing from 14 1/8" to 25 7/8" with 5/8" vertical adjustability.
- For adjustable version see IRS-04038.

#### UL, C-UL (Canada) Listings

- Wet, damp or dry locations, covered ceilings.
- Type IC. Approved for direct contact with insulation.
- Through-branch conductors (4 #12 AWG 90°C).

#### Three Year Limited Warranty

- Complete standard fixture.

### Performance at a Glance

IRS-04028: Type IC

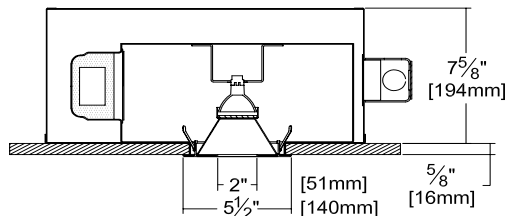

Ceiling Cut-out  
5" Dia.



Type IC



Air Tight

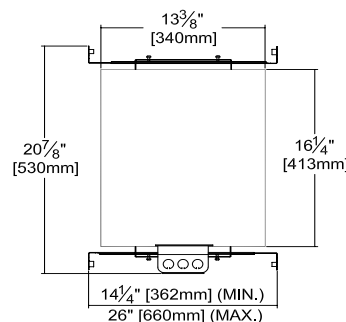

IRS-04028  
(50 Watt SP10)

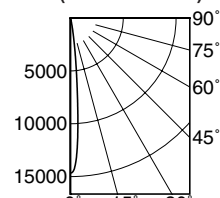

SC = 0.2  
EFFICIENCY: 55.3%  
ITL TEST #58949

IRS-04028  
(50 Watt NFL25)

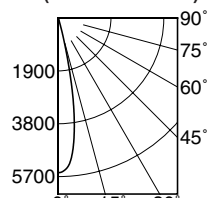

SC = 0.3  
EFFICIENCY: 60.5%  
ITL TEST #58954



Exceptional  
Energy  
Efficiency

For adjustable version see IRS-04038

## THE KIRLIN COMPANY

3401 EAST JEFFERSON AVENUE • DETROIT, MICHIGAN 48207-4232  
(313) 259-6400 • Fax: (313) 259-9409 OR (313) 259-3121 • www.kirlinlighting.com

LOW VOLTAGE TUNGSTEN  
HALOGEN LIGHTING

MAXIMUM WATTAGE

50

CATALOG NUMBER

IRS-04028

DUE TO OUR CONTINUING EFFORT TO IMPROVE PRODUCTS, TECHNICAL INFORMATION IS SUBJECT TO CHANGE WITHOUT NOTICE.

### Detailed Photometry - Installed Fixture

Photometry from I.T.L., Boulder, CO

- D: Distance (in feet) to floor or wall.
- FC: Max. footcandles on surface within effective visual beam. (Visual beam is 50% of max. FC.)
- L: Effective visual beam length in feet.
- W: Effective visual beam width (in feet).

#### FC on Horizontal Plane

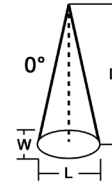

Lamp Angle

#### IRS-04028 (50 Watt)

LAMP: OSRAM SYLVANIA  
50MR16/IR/SP10/C  
TRIM: Open Pin Hole  
EFFIC: 55.3%  
SC: 0.2

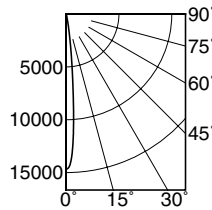

D	FC	L	W
4.0	916	0.7	0.7
6.0	407	1.0	1.0
7.0	299	1.2	1.2
8.0	229	1.4	1.4
9.0	181	1.6	1.6
10.0	147	1.7	1.7
12.0	102	2.1	2.1
14.0	75	2.4	2.4

ITL TEST: #58949

LAMP: OSRAM SYLVANIA  
50MR16/IR/NFL25  
TRIM: Open Pin Hole  
EFFIC: 60.5%  
SC: 0.3

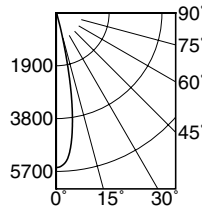

D	FC	L	W
4.0	347	1.5	1.5
6.0	154	2.2	2.2
7.0	113	2.6	2.6
8.0	87	2.9	2.9
9.0	69	3.3	3.3
10.0	56	3.7	3.7
12.0	39	4.4	4.4
14.0	28	5.1	5.1

ITL TEST: #58954

### Options

#### Transformer, Wattage and Voltage

- 58 For 277 volt line input.
- MG Magnetic (conventional) transformer instead.
- TD Toroidal magnetic transformer instead.

#### Trims

- 32 White oversize trim extender. Specify size.
- 35 Natural aluminum acrylic enameled finish.
- 37 Dark Bronze acrylic enameled finish.
- 38 Black acrylic enameled finish.
- 45 Gasket between trim flange and ceiling.

- 79 Collar for ceilings up to 2 5/8" or consult factory.
- 94 Custom color/finish. Specify part(s). Consult factory.
- BN Brushed satin nickel finish.

#### Filters (Specify 1 or 2; 1 clear provided)

- AM Amber filter.
- DP Dichroic Peach filter.
- GE Green / Botanical filter.
- HX Hexcel louver.
- LN Linear glass filter.
- MB Medium Blue filter.

- MP Softening microprismatic filter.
- PF Crystal prismatic filter.
- PK Pink / Rose filter.
- UF Ultraviolet filter.
- XF Filter other than shown. Specify make/model.

#### Other

- 99 Special modification. Consult factory.
- AT Air tight version. Exceeds ASTM E283 restricted airflow of 2 CFM maximum.

### SUBMITTAL DATA

JOB NAME \_\_\_\_\_  
 TYPE \_\_\_\_\_  
 WATTAGE \_\_\_\_\_ VOLTAGE \_\_\_\_\_  
 CATALOG NUMBER \_\_\_\_\_

### APPROVAL STAMP

LIMITED WARRANTY: CATALOGUED KIRLIN FIXTURES ARE WARRANTED FREE OF DEFECTS IN WORKMANSHIP OR MATERIAL FOR THREE YEARS FROM DATE OF PURCHASE. INSTALLED TO N.E.C. IN NORMAL USE. Manufacturer at the option will replace or repair such fixture or refund the purchase price on presentation of proof of purchase and defective fixture at the offices of manufacturer within three years of original shipment. Liability of manufacturer is limited to the foregoing, and manufacturer shall not be liable for any other damages, direct or indirect, sustained or suffered by purchaser or any person. This warranty is subject to the buyer in place of all other warranties, expressed or implied. Seller does not warrant as to merchantability or fitness for a particular use, nor will any oral statement constitute a warranty or amend this specific warranty. Abnormal use, abuse of the fixture, improper installation, or repair or modification of the fixture without prior written authorization from the manufacturer will render the warranty void.