

CATALOG #	TYPE	
JOB NAME	WATTAGE	VOLTAGE

8" 1 PAR 56 500 WATT MAXIMUM

IRR-08087

## Atrium, Church, Mall 500 Watt Downlight

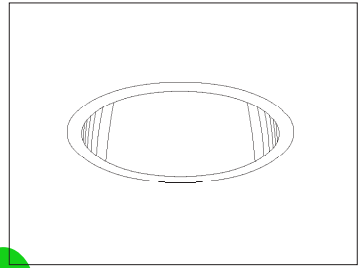

### Specifications

#### Lamp / Socket

- Designed for 1 vertical tungsten halogen lamp (by others): 500W maximum PAR 56.
- Rated 4000 hour life, 100 CRI.
- Dimmable (controls by others).
- Tilts 150° for relamping.
- Safety tempered prismatic C#73 flat glass converts oval beam pattern to round.
- See Option -28 for use with narrow spot lamp.
- Porcelain mogul end-prong vertical socket.

#### Reflector

- Self-flanged parabolic specular Alzak® aluminum.
- Optional reflector finishes, colors and square trim available.

#### Aluminum Housing

- Cool. Acrylic enameled 100% aluminum.
- Rustproof and corrosion resistant: Exceeds 1000 hour ASTM 5% salt spray test.
- Dissipates heat across entire surface area extending component life.

- Entire luminaire visible and serviceable from below through aperture.
- For top access, see Option -TA.
- Built-in plaster frame. Also see Option -79.

#### Outlet Box and Thermal Protection

- UL listed J-box with insulated removable cover. Prewired 14 GA (NEC) with 1/2" and 3/4" knockouts.
- Thermal protector (per current NEC) provides automatic cut-off if rated temperature is exceeded.

#### Installation

- 27" galvanized hanger bars supplied (2).
- Fully adjustable universal galvanized mounting brackets supplied (2).
- Recesses indoor or outdoor in covered ceilings.
- See "MARKED SPACINGS CAUTION" below.

#### UL, C-UL (Canada) Listings

- Wet, damp or dry locations, covered ceilings.
- Through-branch conductors (6 #12 AWG 105°C).

#### Three Year Limited Warranty

- Complete standard fixture.

Recessed Round  
Open Appearance  
Single Reflector

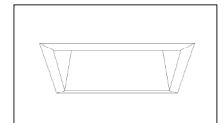

Square Reflector  
Option -SQ

### Performance at a Glance

IRR-08087

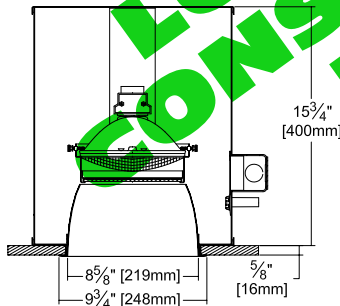

#### Cone of Light Key

- Ft. Distance from fixture
- FC Footcandles at nadir (0°)
- Dia. Circle of light at 50% of FC

\* Dia. (in ft.) shown is where FC value is half the FC at nadir.



Exceptional  
Energy  
Efficiency

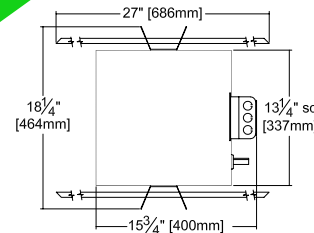

Ceiling Cut-out  
9" Dia.

#### "MARKED SPACINGS CAUTION"

INSTALL WITH MINIMUM SPACINGS AS FOLLOWS: 2 FEET BETWEEN CENTERS OF ADJACENT FIXTURES; 1/2" BETWEEN FIXTURE TOP AND OVERHEAD BUILDING MEMBER; 1 FOOT BETWEEN FIXTURE CENTER AND SIDE WALL.

IRR-08087 (500W Medium Flood)

#### Cone of Light\*

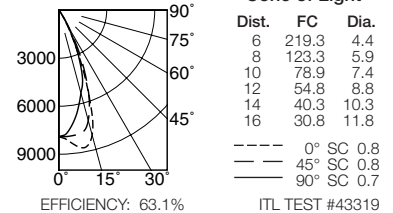

IRR-08087-28 (500W Narrow Spot)

#### Cone of Light\*

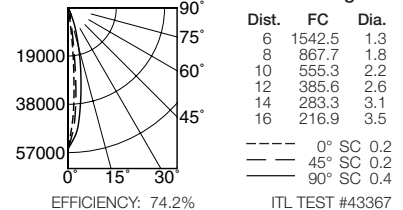

## THE KIRLIN COMPANY

3401 EAST JEFFERSON AVENUE • DETROIT, MICHIGAN 48207-4232  
(313) 259-6400 • Fax: (313) 259-9409 OR (313) 259-3121 • www.kirlinlighting.com

TUNGSTEN HALOGEN &  
INCANDESCENT LIGHTING

MAXIMUM WATTAGE

500

CATALOG NUMBER

IRR-08087

DUE TO OUR CONTINUING EFFORT TO IMPROVE PRODUCTS, TECHNICAL INFORMATION IS SUBJECT TO CHANGE WITHOUT NOTICE.

Alzak® is a registered trademark of ALCOA.

Detailed Photometry - Installed Fixture

Photometry from I.T.L., Boulder, CO

IRR-08087 (500W Medium Flood)

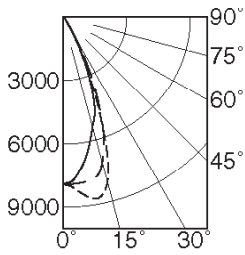

--- 0° SC 0.8  
— 45° SC 0.8  
— 90° SC 0.7

EFFICIENCY : 63.1%

	CANDLEPOWER DISTRIBUTION				
	0.0	22.5	45.0	67.5	90.0
0	7893	7893	7893	7893	7893
5	8269	8269	8269	8269	8269
15	8070	8070	8070	8070	8070
25	2554	2554	2554	2554	2554
35	376	376	376	376	376
45	133	133	133	133	133
55	22	22	22	22	22
65	0	0	0	0	0
75	0	0	0	0	0
85	0	0	0	0	0
90	0	0	0	0	0

RF	COEFFICIENTS OF UTILIZATION						
	20						
	80		50				
RC	70	50	30	10	50	30	10
1	72	71	69	68	67	66	65
2	69	67	64	63	64	62	61
3	66	63	60	58	61	58	57
4	64	60	57	55	58	55	54
5	61	57	54	51	55	53	51
6	59	54	51	49	53	50	48
7	57	52	48	46	51	48	46
8	54	49	46	44	48	46	44
9	52	47	44	42	46	44	42
10	50	45	42	40	45	42	40

ITL TEST #43319

IRR-08087 (500W Narrow Spot)

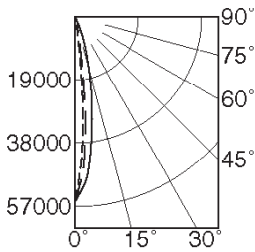

--- 0° SC 0.2  
— 45° SC 0.2  
— 90° SC 0.4

EFFICIENCY : 74.2%

	CANDLEPOWER DISTRIBUTION				
	0.0	22.5	45.0	67.5	90.0
0	55531	55531	55531	55531	55531
5	26499	26499	26499	26499	26499
15	2684	2684	2684	2684	2684
25	988	988	988	988	988
35	43	43	43	43	43
45	9	9	9	9	9
55	0	0	0	0	0
65	0	0	0	0	0
75	0	0	0	0	0
85	0	0	0	0	0
90	0	0	0	0	0

RF	COEFFICIENTS OF UTILIZATION						
	20						
	80		50				
RC	70	50	30	10	50	30	10
1	86	84	83	82	80	79	78
2	83	81	79	77	77	76	75
3	81	78	76	74	75	74	72
4	79	76	73	71	73	71	70
5	77	73	71	69	72	70	68
6	75	71	69	67	70	68	66
7	74	70	67	65	68	66	65
8	72	68	65	64	67	65	63
9	71	67	64	62	66	64	62
10	69	65	63	61	65	62	61

ITL TEST #43367

Options

Lenses and Trims

- 16 Champagne Gold specular Alzak reflector. (CP x .98)
- 28 Tempered clear glass for use with narrow spot lamp. See Option -LP.
- 30 All white reflector. (CP x .98)
- 31 White flange (only) on self-flanged reflector.
- 32 White oversize trim ring. Specify O.D.
- 45 Gasket between ceiling and reflector flange.
- 63 Dune specular Alzak reflector. (CP x .97)
- 69 Wheat specular Alzak reflector. (CP x .97)
- 70 SofTex clear reflector. (CP x .98)
- 71 SofTex Dune reflector. (CP x .95)
- 72 Black specular Alzak reflector. (CP x .80)
- 79 Extension collar for ceilings up to 2" thick.
- 82 Sloped ceiling adapter. Specify slope in 5° increments up to 30°. Not available with -SQ.
- 91 SofTex Wheat reflector. (CP x .95)
- 93 Pewter specular Alzak reflector. (CP x .95)
- 94 Custom color/finish. Specify. Consult factory.

- OG OptiGroove black seamless tapered aluminum reflector. White trim, self-flanged. (CP x .82)
- SQ 8.75" Square self-flanged clear specular reflector instead. (Ceiling cut-out 9.5" sq.)

Other

- 99 Special modification. Consult factory.
- LP With PAR 56 lamp. Specify wattage and beam spread. With narrow spot, also select -28.
- TA Top access for servicing from above ceilings.

SUBMITTAL DATA

APPROVAL STAMP

JOB NAME \_\_\_\_\_  
 TYPE \_\_\_\_\_  
 WATTAGE \_\_\_\_\_ VOLTAGE \_\_\_\_\_  
 CATALOG NUMBER \_\_\_\_\_

LIMITED WARRANTY: CATALOGED KIRLIN FIXTURES ARE WARRANTED FREE OF DEFECTS IN WORKMANSHIP OR MATERIAL FOR THREE YEARS FROM DATE OF PURCHASE. INSTALL TO N.E.C. IN NORMAL USE. Manufacturer of the fixture will replace or repair such fixture or refund the purchase price on presentation of proof of purchase and defective fixture at the offices of manufacturer within three years of original shipment. Liability of manufacturer is limited to the foregoing and manufacturer shall not be liable for any other damages, direct or indirect, sustained or suffered by purchaser or any person. This warranty is supplied to the buyer in place of all other warranties, expressed or implied. Seller does not warrant as to merchantability or fitness for a particular use, nor will any oral statement constitute a warranty or amend the specific warranty. Abnormal use, abuse of the fixture, improper installation, or repair or modification of the fixture without prior written authorization from the manufacturer will render the warranty void.