

CATALOG #	TYPE	
JOB NAME	WATTAGE	VOLTAGE

4" 1 MR16 75 WATT MAXIMUM

IRR-04019

## Open Appearance Lensed Shower Adjustable • Round • Low Voltage

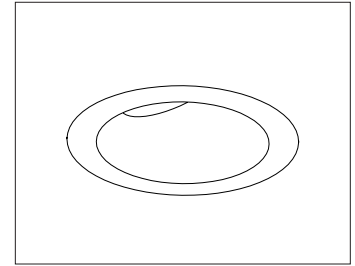

### Specifications

#### Lamp and Optional Filter Holder

- Designed for one 12 volt MR16 lamp (by others): 75 watt maximum.
- For filter holder and up to 2 filters, see Options.

#### Lampholder

- Heat resistant GX5.3 base porcelain socket.
- 300°C rated double wipe nickel plated contacts provide secure fit and optimal conductivity.
- Securely mounted within aluminum heat sink: protects lamp base, maintains secure fit.
- Insulated lead wires suitable for 250°C operation.

#### Lamp Module - Center Beam Positioning

- Hot aiming by hand or screwdriver provides locking adjustability from 0° to 45° in precise 1° increments.
- Accommodates sloped ceilings up to 45°.
- Full 365° locking rotational disk indexed for optimal lamp-trim position.
- Black concealment shroud screens fixture interior.
- All aluminum for maximum heat dissipation

and cool operation of entire lamp-socket-trim module.

#### WhisperPack™ Encapsulated Transformer

- Exclusive WhisperPack™ isolates and envelops transformer with proprietary heat and sound absorbing material.
- Provides longer life and cooler, quieter operation. Easily accessible through ceiling aperture.
- Electronic dimmable stepdown (120V/12V) 90°C AC transformer. See Options for magnetic or toroidal versions and for 277 volt operation.

#### Electrically Isolated Trim

- Specular, clear aluminum self-flanged, gasketed angle cut cone with tempered microprismatic lens on top. Optional lenses, SofTex finishes, colors, white flange, or downlight cone versions available.
- Non-conductive vinyl coated trim spring clips minimize risk of electric shock.

#### Acrylic Enameled Aluminum Housing

- Rustproof and corrosion resistant: Exceeds 1000 hour ASTM 5% salt spray test.
- Shallow depth fits restricted plenums.
- Cool operation: Extends life of all components.
- Entire luminaire easily serviced through aperture.
- Built-in plaster flange.

- For Air Tight or Top Access, see Options.

#### Outlet Box and Thermal Protection

- UL listed J-box with insulated removable cover. Prewired 14GA (NEC) with ½" and ¾" knockouts.
- Thermal protector (per current NEC) provides automatic cut-off if rated temperature is exceeded.

#### Installation

- Recesses indoor or outdoor in covered locations.
- Accommodates ceilings up to 1¼" thick.
- Hardware provided suitable for grid or wood joist ceilings with spacing from 14½" to 25½" with ⅝" vertical adjustability.
- For downlight cone instead, see Option -DL.

#### UL, C-UL (Canada) Listings

- Wet, damp or dry locations, covered ceilings.
- Through-branch conductors (6 #12 AWG 90°C).

#### Three Year Limited Warranty

- Complete standard fixture.

### Performance at a Glance

IRR-04019

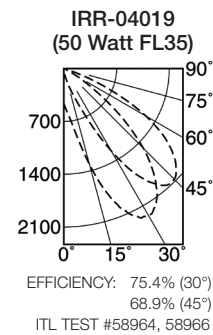
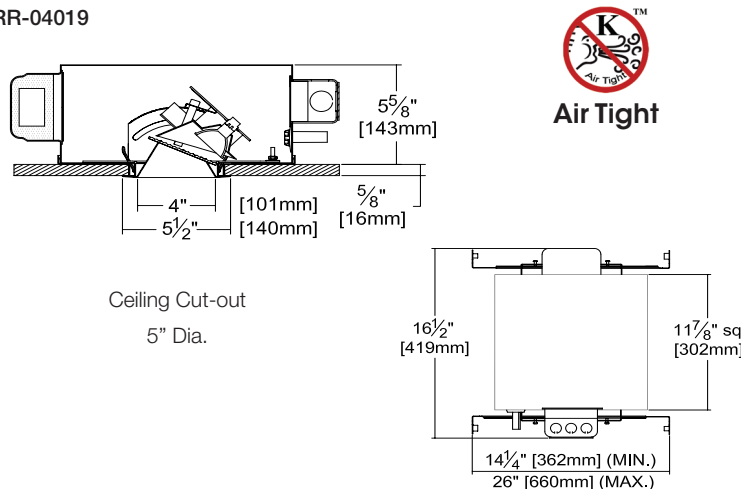

For downlight cone instead, see Option -DL

## THE KIRLIN COMPANY

3401 EAST JEFFERSON AVENUE • DETROIT, MICHIGAN 48207-4232  
(313) 259-6400 • Fax: (313) 259-9409 OR (313) 259-3121 • www.kirlinlighting.com

LOW VOLTAGE TUNGSTEN  
HALOGEN LIGHTING

MAXIMUM WATTAGE

75

CATALOG NUMBER

IRR-04019

DUE TO OUR CONTINUING EFFORT TO IMPROVE PRODUCTS, TECHNICAL INFORMATION IS SUBJECT TO CHANGE WITHOUT NOTICE.

**Photometry - Installed Fixture**

Photometry from I.T.L., Boulder, CO

- D: Distance (in feet) to floor or wall.
- FC: Max. footcandles on surface within effective visual beam. (Visual beam is 50% of max. FC.)
- L: Effective visual beam length in feet.
- W: Effective visual beam width (in feet).
- CB: Distance (in feet) to center beam.

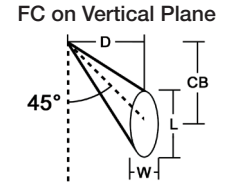
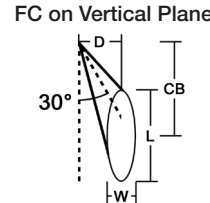
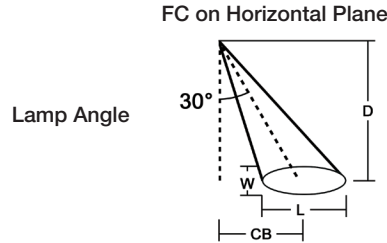

**IRR-04019 (50 Watt)**

**LAMP:** OSRAM SYLVANIA  
50MR16/IR/FL35/C  
**TRIM:** Open Appearance  
Specular Shower  
**EFFIC:** 75.4% (30°)  
68.9% (45°)

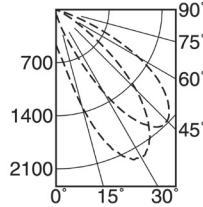

D	FC	L	W	CB
4.0	98	2.8	2.7	2.3
6.0	44	4.2	4.0	3.5
7.0	32	4.9	4.7	4.0
8.0	25	5.6	5.4	4.6
9.0	19	6.4	6.1	5.2
10.0	16	7.1	6.7	5.8
12.0	11	8.5	8.1	6.9
14.0	8	9.9	9.4	8.1

ITL TEST: #58964

D	FC	L	W	CB
2.0	132	2.2	1.8	3.5
3.0	59	3.3	2.7	5.2
4.0	33	4.4	3.6	6.9
5.0	21	5.5	4.5	8.7
6.0	15	6.6	5.4	10.4
8.0	8	8.8	7.2	13.9
10.0	5	10.9	9.0	17.3
12.0	4	13.1	10.8	20.8

ITL TEST: #58964

D	FC	L	W	CB
2.0	229	1.7	1.5	2.0
3.0	102	2.5	2.3	3.0
4.0	57	3.3	3.1	4.0
5.0	37	4.2	3.8	5.0
6.0	25	5.0	4.6	6.0
8.0	14	6.6	6.1	8.0
10.0	9	8.3	7.7	10.0
12.0	6	10.0	9.2	12.0

ITL TEST: #58966

**Options**

**Transformer, Wattage and Voltage**

- 58 For 277 volt line input.
- MG Magnetic (conventional) transformer instead.
- TD Toroidal magnetic transformer instead.

**Lenses - Mounted Above Trim**

- 15 C#73 prismatic tempered spread lens.
- 28 UV absorbing clear tempered lens.
- FP Frosted prismatic tempered lens

**Trims**

- 30 All white acrylic enameled cone.
- 31 White acrylic enameled cone flange.
- 32 White oversize trim ring. Specify O.D.
- 46 Gasket between trim flange and lens.
- 59 Dark Bronze specular self-flanged cone.

- 60 SofTex Dark Bronze self-flanged cone.
- 63 Dune specular self-flanged cone.
- 69 Wheat specular self-flanged cone.
- 70 SofTex Clear self-flanged cone.
- 71 SofTex Dune self-flanged cone.
- 72 Black specular self-flanged cone.
- 77 SofTex Pewter self-flanged cone.
- 79 Collar for ceilings up to 2 5/8" or consult factory.
- 91 SofTex Wheat self-flanged cone.
- 93 Pewter specular self-flanged cone.
- 94 Custom color/finish. Specify. Consult factory.

**Filter Holder / Filters (Specify 1 or 2)**

- FL Filter holder with up to two filter capacity.
- AM Amber filter.
- CL Clear tempered glass filter.
- DP Dichroic Peach filter.
- GE Green / Botanical filter.

- HX Hexcel louver.
- LN Linear glass filter.
- MB Medium Blue filter.
- MP Softening micropismatic filter.
- PF Crystal prismatic filter.
- PK Pink / Rose filter.
- UF Ultraviolet filter.
- XF Filter other than shown. Specify make/model.

**Top Access**

- TA For servicing from above.

**Other**

- 99 Special modification. Consult factory.
- AT Air tight version. Exceeds ASTM E283 restricted airflow of 2 CFM maximum.
- DL Downlight cone instead. Clear specular finish standard or add optional trim selection.

**SUBMITTAL DATA**

JOB NAME \_\_\_\_\_  
 TYPE \_\_\_\_\_  
 WATTAGE \_\_\_\_\_ VOLTAGE \_\_\_\_\_  
 CATALOG NUMBER \_\_\_\_\_

**APPROVAL STAMP**

LIMITED WARRANTY: CATALOGED KIRLIN FIXTURES ARE WARRANTED FREE OF DEFECTS IN WORKMANSHIP OR MATERIAL FOR THREE YEARS FROM DATE OF PURCHASE. INSTALLATION TO N.E.C. IS NORMAL USE. Manufacturer of the option will replace or repair such fixture or refund the purchase price on presentation of proof of purchase and defective fixture at the office of manufacturer within three years of original shipment. Liability of manufacturer is limited to the foregoing, and manufacturer shall not be liable for any other damages, direct or indirect, sustained or suffered by purchaser or any person. This warranty is subject to the buyer in place of all other warranties, expressed or implied. Seller does not warrant as to merchantability or fitness for a particular use, nor will any oral statement constitute a warranty or amend this specific warranty. Abnormal use, abuse of the fixture, improper installation, or repair or modification of the fixture without prior written authorization from the manufacturer will render the warranty void.