

CATALOG #	TYPE	
JOB NAME	WATTAGE	VOLTAGE

4" 1 MR16 50 WATT MAXIMUM **Type IC - IRR-04008**

Open Appearance Lensed Shower Downlight • Round • Low Voltage

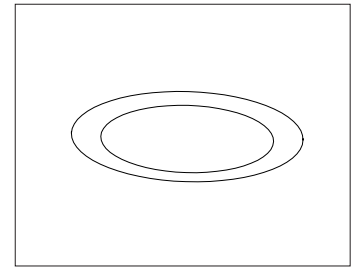

Specifications

Lamp and Optional Filter Holder

- Designed for one 12 volt MR16 lamp (by others): 50 watt maximum.

- For filter holders and up to 2 filters, see Options.

Lampholder

- Heat resistant GX5.3 base porcelain socket.
- 300°C rated double wipe nickel plated contacts provide secure fit and optimal conductivity.
- Securely mounted within aluminum heat sink: protects lamp base, maintains secure fit.
- Insulated lead wires suitable for 250°C operation.

Lamp Module

- All aluminum for maximum heat dissipation and cool operation of entire lamp-socket-trim module.

WhisperPack™ Encapsulated Transformer

- Exclusive WhisperPack™ isolates and envelops transformer with proprietary heat and sound absorbing material.
- Provides longer life and cooler, quieter

operation. Easily accessible through ceiling aperture.

- Electronic dimmable stepdown (120V/12V) 90°C AC transformer. See Options for magnetic or toroidal versions and for 277 volt operation.

Electrically Isolated Trim

- Specular, clear aluminum self-flanged, gasketed downlight cone with tempered microprismatic lens on top. Optional lenses, SofTex finishes, colors and white flange versions available.
- Non-conductive vinyl coated trim spring clips minimize risk of electric shock.

Acrylic Enameled Aluminum Housing

- Rustproof and corrosion resistant: Exceeds 1000 hour ASTM 5% salt spray test.
- Dual housing design includes air chamber for maximum heat dissipation.
- Cool operation: Extends life of all components.
- Entire luminaire easily serviced through aperture.
- Built-in plaster flange.
- For Air Tight or Top Access, see Options.

Outlet Box and Thermal Protection

- UL listed J-box with insulated removable

cover. Prewired 14GA (NEC) with ½" and ¾" knockouts.

- Thermal protector (per current NEC) provides automatic cut-off if rated wattage is exceeded.

Installation

- Recesses indoor or outdoor in covered locations.
- Accommodates ceilings up to 1¼" thick.
- Hardware provided suitable for grid or wood joist ceilings with spacing from 14⅞" to 25⅞" with ⅝" vertical adjustability.
- For adjustable version see IRR-04020.

UL, C-UL (Canada) Listings

- Wet, damp or dry locations, covered ceilings.
- Type IC. Approved for direct contact with insulation.
- Through-branch conductors (4 #12 AWG 90°C).

Three Year Limited Warranty

- Complete standard fixture.

Performance at a Glance

IRR-04008: Type IC

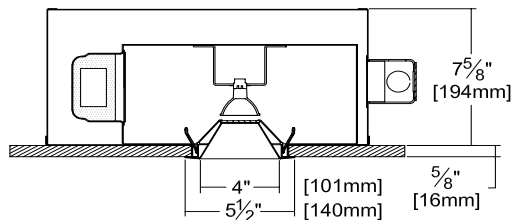

Ceiling Cut-out
5" Dia.

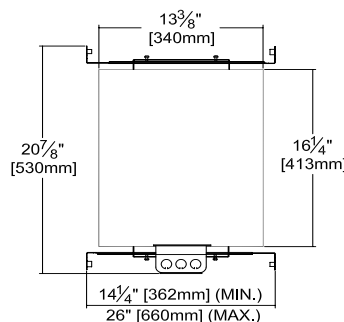

IRR-04008
(50 Watt FL35)

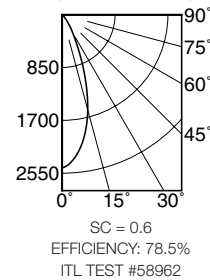

IRR-04008
(50 Watt VWFL60)

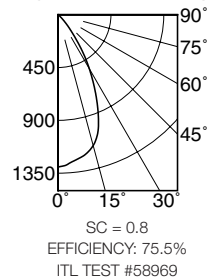

Exceptional
Energy
Efficiency

For adjustable version see IRR-04020

THE KIRLIN COMPANY

3401 EAST JEFFERSON AVENUE • DETROIT, MICHIGAN 48207-4232
(313) 259-6400 • Fax: (313) 259-9409 OR (313) 259-3121 • www.kirlinlighting.com

LOW VOLTAGE TUNGSTEN
HALOGEN LIGHTING

MAXIMUM WATTAGE

50

CATALOG NUMBER

IRR-04008

DUE TO OUR CONTINUING EFFORT TO IMPROVE PRODUCTS, TECHNICAL INFORMATION IS SUBJECT TO CHANGE WITHOUT NOTICE.

Detailed Photometry - Installed Fixture

Photometry from I.T.L., Boulder, CO

- D: Distance (in feet) to floor or wall.
- FC: Max. footcandles on surface within effective visual beam. (Visual beam is 50% of max. FC.)
- L: Effective visual beam length in feet.
- W: Effective visual beam width (in feet).

FC on Horizontal Plane

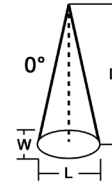

Lamp Angle

IRR-04008 (50 Watt)

LAMP: OSRAM SYLVANIA
50MR16/IR/FL35/C
TRIM: Open Appearance
Shower
EFFIC: 78.5%
SC: 0.6

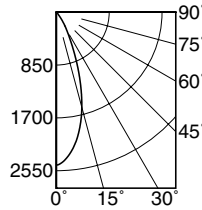

D	FC	L	W
4.0	154	2.4	2.4
6.0	68	3.6	3.6
7.0	50	4.2	4.2
8.0	38	4.8	4.8
9.0	30	5.4	5.4
10.0	25	6.1	6.1
12.0	17	7.3	7.3
14.0	13	8.5	8.5

ITL TEST: #58962

LAMP: OSRAM SYLVANIA
50MR16/IR/VWFL60/C
TRIM: Open Appearance
Shower
EFFIC: 75.5%
SC: 0.8

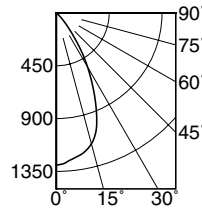

D	FC	L	W
4.0	81	3.5	3.5
6.0	36	5.2	5.2
7.0	26	6.1	6.1
8.0	20	7.0	7.0
9.0	16	7.9	7.9
10.0	13	8.7	8.7
12.0	9	10.5	10.5
14.0	7	12.2	12.2

ITL TEST: #58969

Options

Transformer, Wattage and Voltage

- 58 For 277 volt line input.
- MG Magnetic (conventional) transformer instead.
- TD Toroidal magnetic transformer instead.

Lenses - Mounted Above Trim

- 15 C#73 prismatic tempered spread lens.
- 28 UV absorbing clear tempered lens.
- FP Frosted prismatic tempered lens

Trims

- 30 All white acrylic enameled cone.
- 31 White acrylic enameled cone flange.
- 32 White oversize trim ring. Specify O.D.
- 46 Gasket between trim and lens.
- 59 Dark Bronze specular self-flanged cone.

- 60 SofTex Dark Bronze self-flanged cone.
- 63 Dune specular self-flanged cone.
- 69 Wheat specular self-flanged cone.
- 70 SofTex Clear self-flanged cone.
- 71 SofTex Dune self-flanged cone.
- 72 Black specular self-flanged cone.
- 77 SofTex Pewter self-flanged cone.
- 79 Collar for ceilings up to 2 5/8" or consult factory.
- 91 SofTex Wheat self-flanged cone.
- 93 Pewter specular self-flanged cone.
- 94 Custom color/finish. Specify. Consult factory.

Filter Holder / Filters (Specify 1 or 2)

- FL Filter holder on lamp or see Option -TF.
- AM Amber filter.
- CL Clear tempered glass filter.
- DP Dichroic Peach filter.

- GE Green / Botanical filter.
- HX Hexcel louver.
- LN Linear glass filter.
- MB Medium Blue filter.
- MP Softening micropismatic filter.
- PF Crystal prismatic filter.
- PK Pink / Rose filter.
- TF Trim mounted filter holder instead.
- UF Ultraviolet filter.
- XF Filter other than shown. Specify make/model.

Other

- 99 Special modification. Consult factory.
- AT Air tight version. Exceeds ASTM E283 restricted airflow of 2 CFM maximum.

SUBMITTAL DATA

JOB NAME _____
TYPE _____
WATTAGE _____ VOLTAGE _____
CATALOG NUMBER _____

APPROVAL STAMP

LIMITED WARRANTY: CATALOGUED KIRLIN FIXTURES ARE WARRANTED FREE OF DEFECTS IN WORKMANSHIP OR MATERIAL FOR THREE YEARS FROM DATE OF PURCHASE. INSTALLATION TO N.E.C. IN NORMAL USE. Manufacturer of the option will replace or repair such fixture or refund the purchase price on presentation of proof of purchase and objective testing at the office of manufacturer within three years of original shipment. Liability of manufacturer is limited to the foregoing, and manufacturer shall not be liable for any other damages, direct or indirect, sustained or suffered by purchaser or sufferer by purchaser or sufferer in place of all other warranties, expressed or implied. Seller does not warrant as to merchantability or fitness for a particular use, nor will any oral statement constitute a warranty or amend this specific warranty. Abnormal use, abuse of the fixture, improper installation, or repair or modification of the fixture without prior written authorization from the manufacturer will render the warranty void.