



Choice Series

Premier Architectural LED Luminaires



CHRIS
Executive Vice President



CHAD
National Sales Manager



AMANDA
Regional Manager - West



SCOTT
Regional Manager - Central

Key Focus Areas



ARCHITECTURAL LIGHTING COLLECTIONS



Choice Series
Premier Architectural Luminaires



Symphony Series
Remote Driver System



Wayfinding Series
NightLights, StepLights, Sconces



Shoreview Series
Environmental & Turtle-Safe



Latitudes Series
Discrete LED Luminaires



Kirlin Select
Value LED Luminaires



Gazelle Express
Quick Ship Line



LED Retrofit Kits

Hallmarks of Kirlin Value

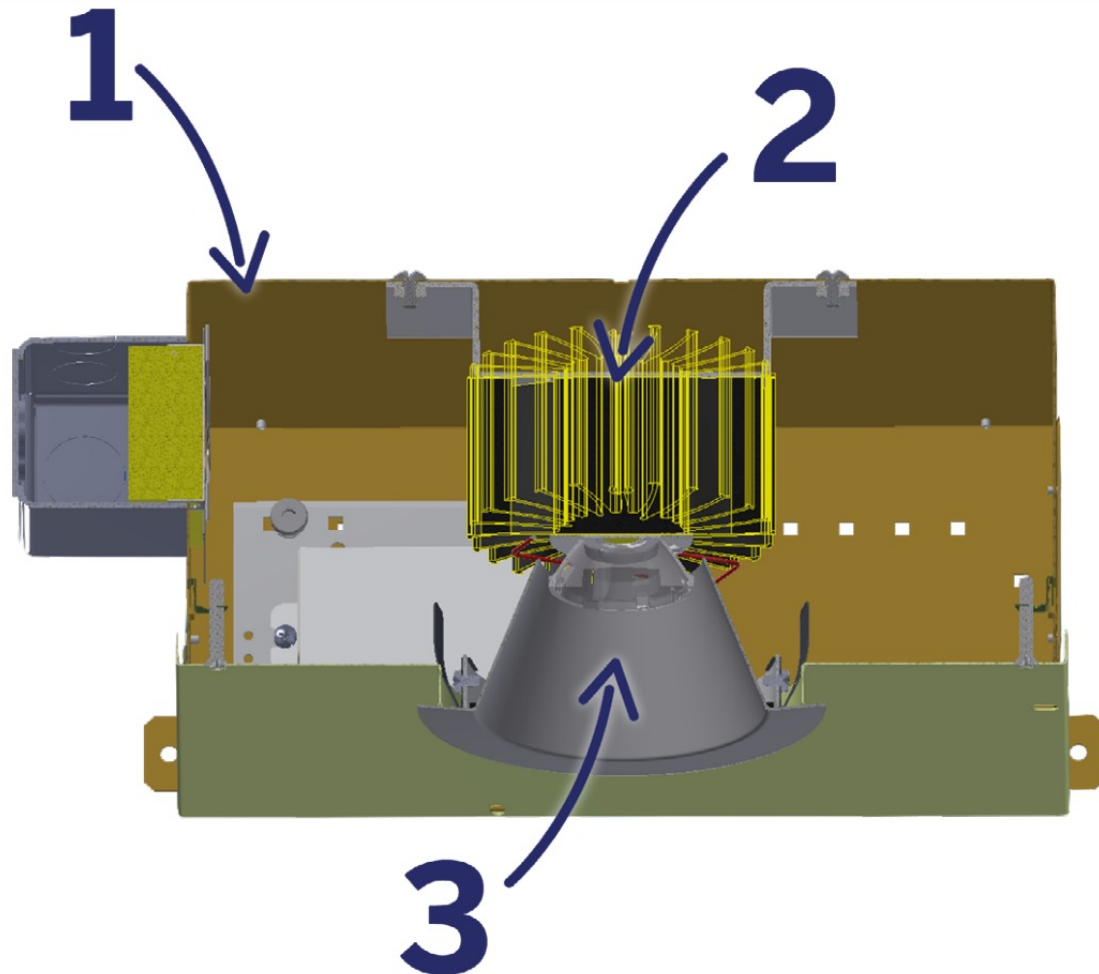

1 “Gold Standard” Housing

Kirlin’s acrylic enameled gold aluminum housing is rust-proof, corrosion resistant, and proven to withstand the ASTM 1,000 hour salt spray test. Most importantly, components in a Kirlin housing operate 5°C cooler than in an identical steel housing, enabling safe contact with insulation (Type IC) up to 4000L.

2 Sustainable Upgrade-Ready Design

All Kirlin products are designed with long-term sustainability in mind. Modular construction promotes seamless upgrades to the latest, greatest, most energy efficient source technology, and cost-effective remodeling without disruption of existing ceilings. Fixture components are visible and conveniently serviceable through the luminaire aperture.

3 Precision Optics & Glare Control

LED source modules, specialty optics, lenses, diffusers, and reflectors work in harmony to produce the optimal beam pattern for any application. Clean, architectural cutoffs and high quality one-piece anodized trims minimize glare. Precisely engineered optical design maximizes visual comfort while delivering high light levels efficiently.

Choice Series: COB-Powered Luminaires

- 3 Chip-on-Board sizes (13mm, 15mm, 22mm) support lumen packages from 1,000-10,500 **delivered lumens.**
- Fixture efficacy up to 122 LPW (LRC-06LDN)
- Ultimate color consistency – moving to 2 SDCM
- All this without losing any optical control!

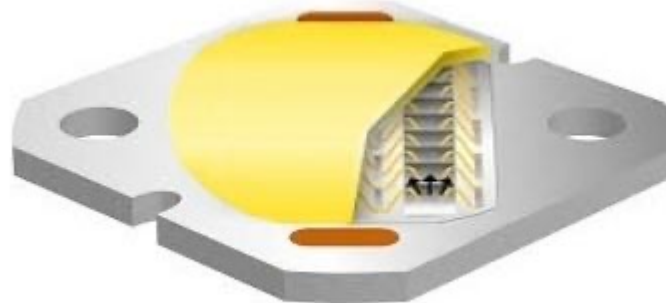

Choice Series

Super Shallow 4" Downlight • COB LED

2¾" Housing Depth • 50,000+ Hours • Type IC • 1.0% Dimming
2 or 3 Step Binning • Wet Listed • LM-80 and LM-79 Certified

Specifications

Delivered System Performance

- Lumen Series: **Must Specify**
- | Type IC | Non-IC |
|---------|--------|
| -3000L | -4000L |
| -2500L | |
| -2000L | |
| -1500L | |
| -1000L | |
- Select trim & beam distribution: see chart
- Select color (CCT): see chart; 80+ CRI standard; Option -HC for 90+ (15% lumen loss)
- 60,000 hour life, 50,000 in insulation

CATALOG #	TYPE	
JOB NAME	WATTAGE	VOLTAGE

LRC-04SDN

Trim Options

-  -RND
-  -SQR
-  -FTR
-  -PTR

- Decorative brushed nickel "Porthole" trim with frosted microprismatic lens (-PTR)
- Optional colors and finishes available

Acrylic Enameled Aluminum Housing

- Rustproof: exceeds 1000 hour ASTM 5% salt spray test; all components fully sustainable
- Shallow depth for restricted plenums
- Cool operation extends component life
- Modular design; visible and fully serviceable through aperture

Outlet Box (Galvanized)

- UL Listed, 14GA, insulated, removable cover
- ½" and ¾" knockouts
- Up to 4 #12 AWG through-branch conductors

Installation & Hardware

- Indoor/outdoor in ceilings up to 1½" thick
- Compatible with fire rated enclosures (by others)
- 27" hanger bars & adjusting brackets (2) supplied

UL, C-UL (Canada) & FCC Compliance

- UL Listed: wet, damp or dry locations,

- FCC Part 15 certified for EMI/RFI emissions

FIVE YEAR Limited Warranty







- Complete standard fixture



How Does “Choice” Stack Up?

What's Goes Up?	What's Goes Down?	What Stays the Same?
<ul style="list-style-type: none">▲ Max. Lumen Packages (7,000 recessed; 10,500 surface)▲ Efficacy (> 100 lm/Watt)▲ Type IC Threshold (up to 4000 lumens)▲ Ease of Specification	<ul style="list-style-type: none">▼ Standard Low-End Dimming (now 1%)▼ Aperture size of smallest vandal/behavioral and IP66 trim (<i>now 4"</i>)▼ Number of Fixture Models to Remember▼ Price	<ul style="list-style-type: none">✓ Kirlin Corrosion-Resistant Acrylic Enameled Housing✓ Kirlin Exceptional Thermal Management✓ Specialty Listings: UL Wet Listed, IP66, IP65, NSF, ISO 5 / Class 100 Cleanroom, IK10 Impact Resistant✓ Selection of Optical Distributions

Luminaire Features & Specifications

 SELECTION	Downlight, adjustable, wall wash, shower, cylinder, surface square, up/down, vandal
 FIXTURE OUTPUT	1000, 1500, 2000, 2500, 3000, 4000, 5000, 6000, 7000, 8500, 10500 lumens available
 COLOR TEMP	Choice of 2700K, 3000K, 3500K, 4000K, or 5000K
 COLOR RENDERING	Choice of 80+ CRI or 90+ CRI
 OPTICAL CONTROL	Precision engineered optics and reflectors maximize efficiency and provide up to 4 unique beam spreads per fixture (0.3 to 1.1 SC) 15-30° - SPT 30-45° - NFL 45-65° - MFL 65-105° - WFL
 LONGEVITY	Up to 60,000 hour L70
 INSULATION-SAFE	Type IC standard on up to 4000L on 6" recessed fixtures, up to 3000L on 4" fixtures

Recessed: 22 Fixtures Across Two Categories

ReCESsed Timeless Classics

ReCESsed Speciality Luminaires

K Choice Series
ARCHITECTURAL LED LIGHTING

SHAPE

LUMENS

1000L
1500L
2000L
2500L
3000L
4000L Type IC
5000L
6000L
7000L

COLOR TEMP

27K 30K 35K 40K 50K

CRI

80+ 90+

BEAM

20° SPT
40° NFL
50° MFL
70° WFL

IK 10 VR IP65 IP66 100

Timeless Classics:

- Pinholes
- Architectural Downlights
- Adjustable Downlights
- Wall Washes
- Classic Kirlin K-Lens

Specialty Luminaires:

- Super Shallow Downlight
- Shower Light
- IP65, IP66, NSF, & Clean Room
- Vandal & Ligature Resistant
- Drop Lens Bisymmetric

Timeless Classics

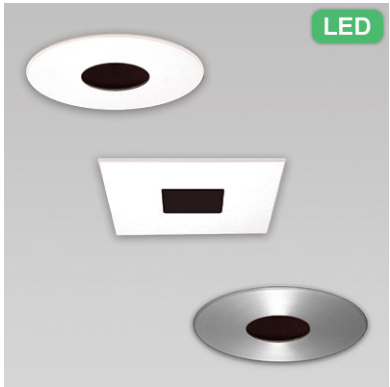

LED

LRC-02PND

2" Pinhole 1000-2500L



LED

LRC-04CDN

4" Open 1000-4000L



LED

LRC-04CAD

4" Adjustable 1000-4000L



LED

LRC-04LWW

4" Wall Wash 750-3000L



LED

LRC-04LDN

4" Lensed 1000-4000L



LED

LRC-08KLD

8" K-Lens 1000-3000L

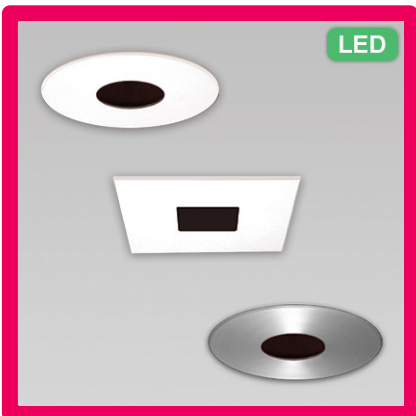

LED

LRC-02PNA

2" Adj. Pinhole 1000-2500L



LED

LRC-06CDN

6" Open 1000-7000L



LED

LRC-06CAD

6" Adjustable 1000-7000L



LED

LRC-06LWW

6" Wall Wash 1000-7000L



LED

LRC-06LDN

6" Lensed 1000-7000L



LED

LRC-10KLD

10" K-Lens 1000-7000L

LRC-02PNA: 2" Adjustable Pinhole

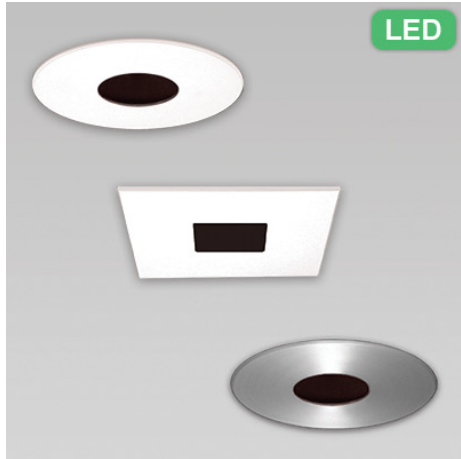

- 807-2325 delivered lumens
- Up to 45° tilt; 360° rotation
- 4 beam spreads: 27° to 61°

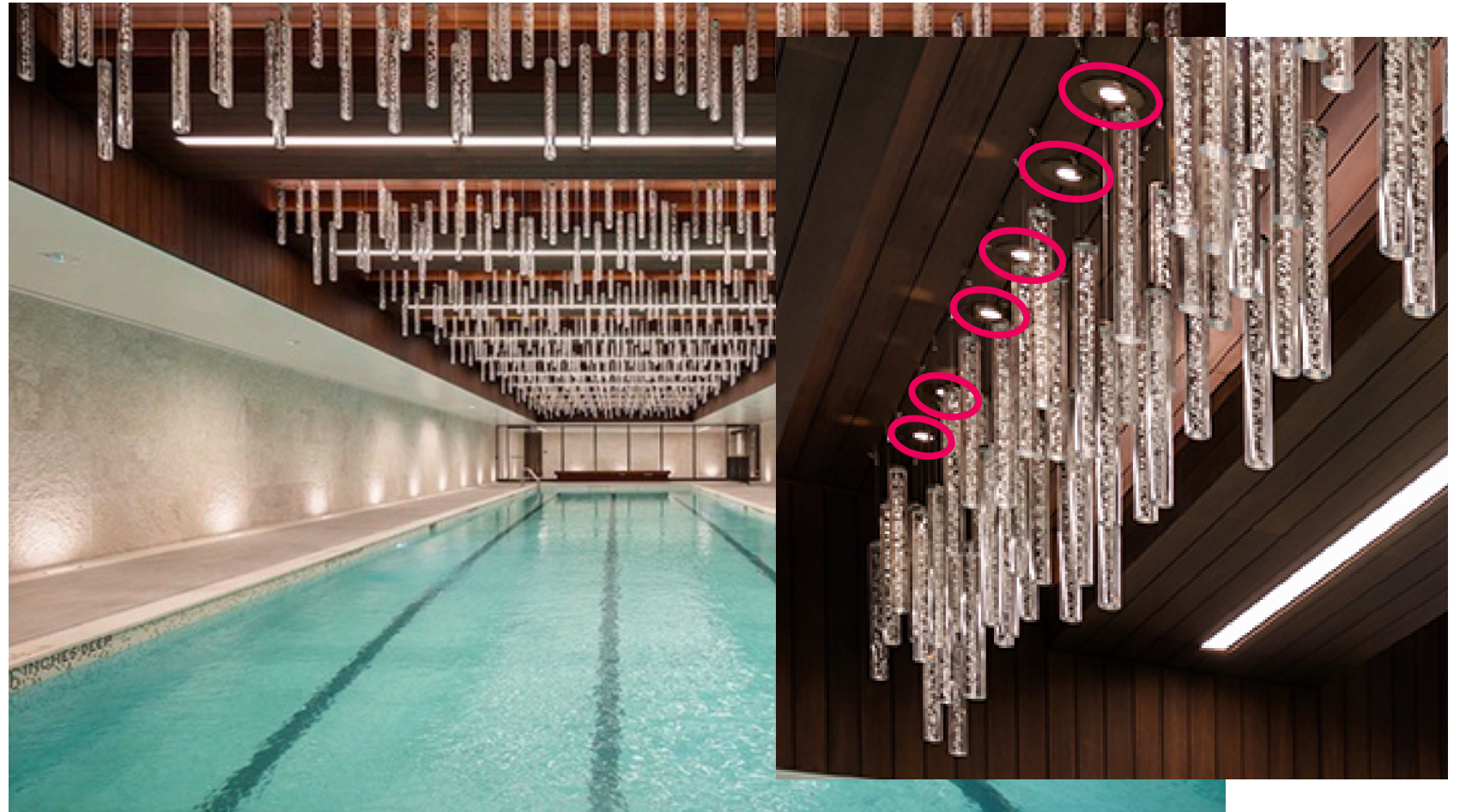
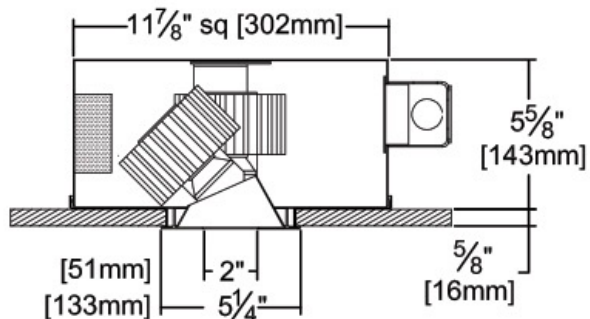

LRC-02PNA: 2" Adjustable Pinhole

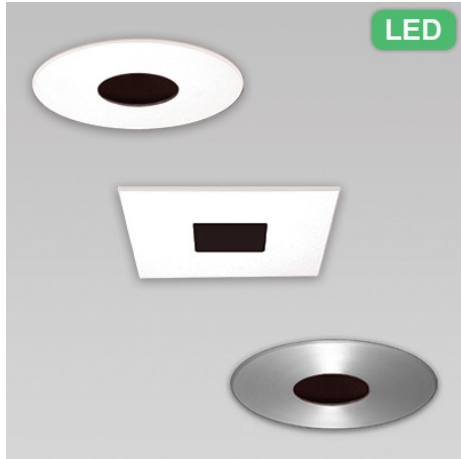

- 807-2325 delivered lumens
- Up to 45° tilt; 360° rotation
- 4 beam spreads: 27° to 61°

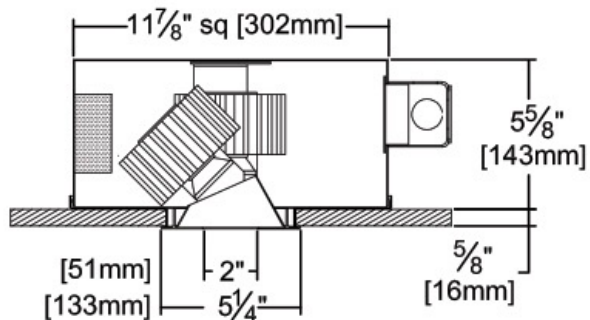

Timeless Classics

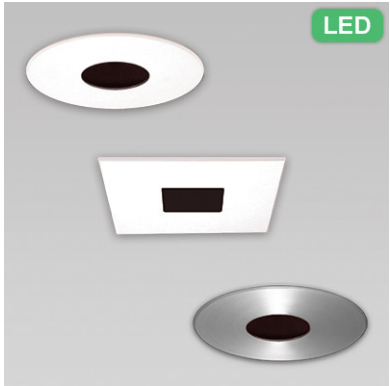

LRC-02PND

2" Pinhole 1000-2500L



LRC-04CDN

4" Open 1000-4000L



LRC-04CAD

4" Adjustable 1000-4000L



LRC-04LWW

4" Wall Wash 750-3000L



LRC-04LDN

4" Lensed 1000-4000L



LRC-08KLD

8" K-Lens 1000-3000L

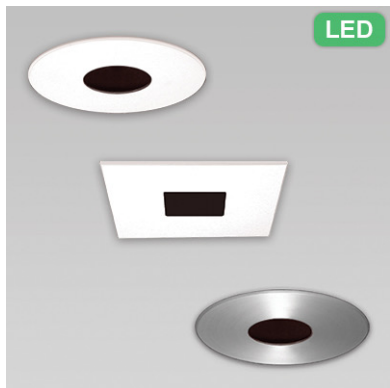

LRC-02PNA

2" Adj. Pinhole 1000-2500L

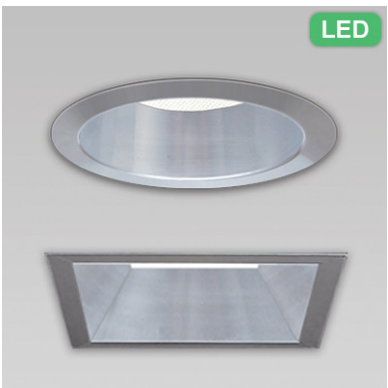

LRC-06CDN

6" Open 1000-7000L



LRC-06CAD

6" Adjustable 1000-7000L



LRC-06LWW

6" Wall Wash 1000-7000L



LRC-06LDN









6" Lensed 1000-7000L



LRC-10KLD

10" K-Lens 1000-7000L

Specialty Luminaires

 Shallow Plenum
  NSF Certified
  IP65
  IP66
  BioGard™
  VR Vandal Resistant
  IK10 Impact Resistant
  ISO 5/Class 100



LRC-04SDN

4" Super Shallow 1000-4000L



LRC-05SDN

5-6" Super Shallow 1000-4000L

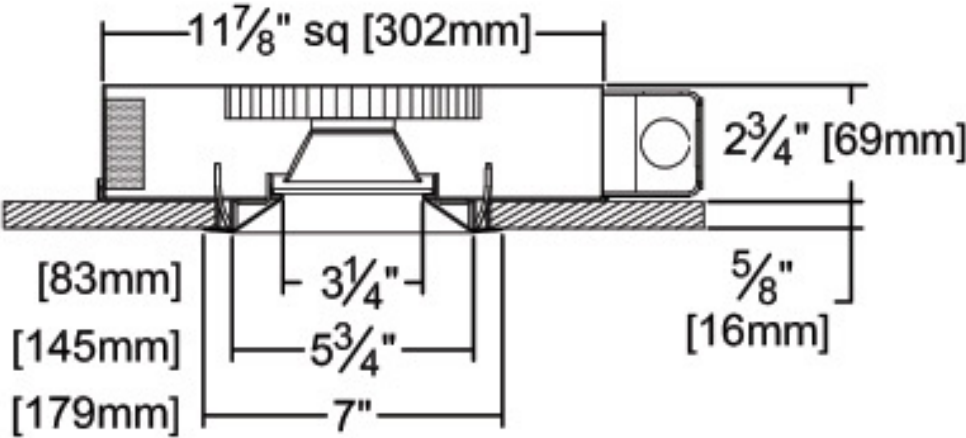

LRC-05SDN

LRC-04VND: 4" Vandal/Behavioral Downlight

VR Vandal Resistant **IK10** IK10 Impact Resistant **IP66** IP66 **BioGard™** BioGard™ **ISO 5 / CLASS 100** ISO 5/Class 100 CLEANROOM

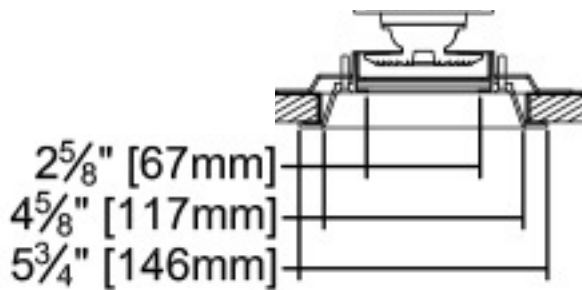

**Delivers over
2200 lumens!**



LRC-04VND: 4" Vandal/Behavioral Downlight

1

LEVEL 1

 BioGard Antimicrobial Finish

PLENUM

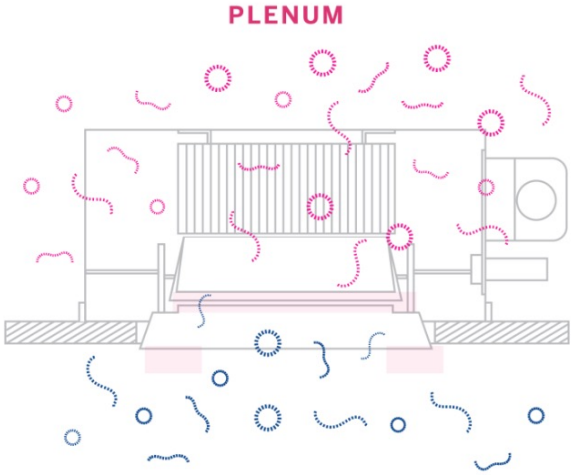

ENVIRONMENT

2

LEVEL 2

 IP66 Sealed Trim

 BioGard Antimicrobial Finish

PLENUM

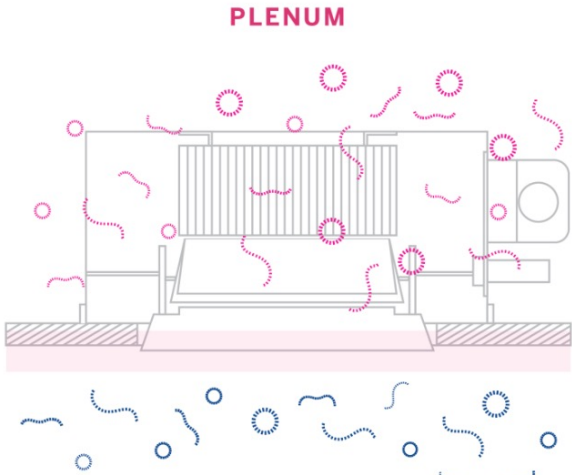

ENVIRONMENT

3

LEVEL 3

 ISO 5 / Class 100 Sealed Cleanroom Fixture with IP66 Trim

 BioGard Antimicrobial Finish

PLENUM

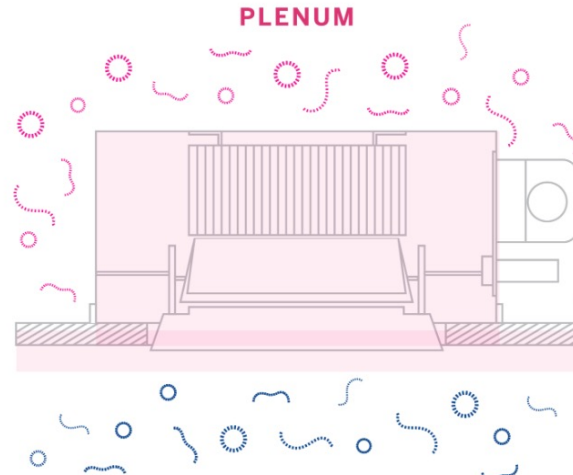

ENVIRONMENT

Trim Finish Examples

Trim Finish Options

**SofTex™
Semi-Specular**

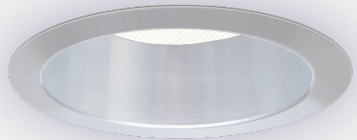

**Clear Specular
Option -62T**



**White Flange
Option -30F**

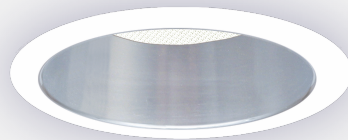

**Black Flange
Option -38F**

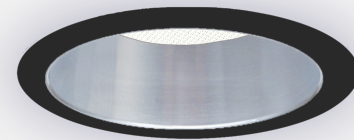

**Bronze Flange
Option -37F**

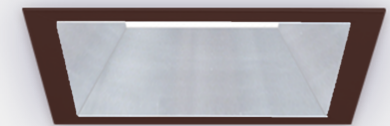
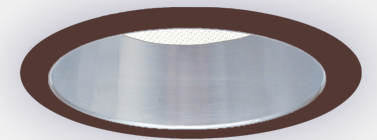

Surface/Wall: 12 Fixtures Across Two Categories

Surface Mounted Cylinders & Squares

Surface Mounted Direct/Indirect Luminaires

K Choice Series
ARCHITECTURAL LED LIGHTING

SHAPE	
LUMENS	1000L 1500L 2000L 2500L 3000L 4000L 5000L 6000L 7000L 8500L 10500L
COLOR TEMP	27K 30K 35K 40K 50K
CRI	80+ 90+
BEAM	20° SPT 40° NFL 50° MFL 70° WFL

Surface/Pendant Downlights:

- 3" to 13" diameter
- 4" to 18" height
- Super Shallow 4x12 "hockey puck"
- Classic Kirlin K-Lens
- Up to 10,500 delivered lumens

Direct/Indirect:

- 3" to 9" diameter
- 12" to 19" height
- Up to 5000 delivered lumens up and 5000 delivered lumens down

Downlight Cylinders



LSC-03RDN

3"x12" Cylinder 1000-4000L



LSC-06RDN

6"x15" Cylinder 1000-5000L



LSC-07SDN

7"x18" Square 2000-7000L



LSC-09RDN

9"x16" Cylinder 2000-7000L



LSC-11RDN

11"x18" Cylinder 3,000-10,500L



LSC-12RSD

12"x4" Cylinder 1000-4000L



LSC-13SDN

13"x9" Square 1000-7000L



LSC-14DLD

14"x8" Square 1000-7000L

Direct/Indirect

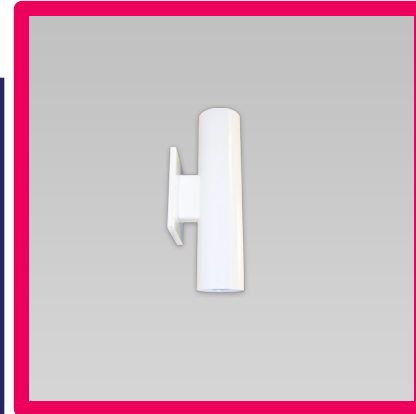

LWC-03RDI

3"x12" Up/Down 1000-2000L



LWC-06RDI

6"x18" Up/Down 1000-3500L

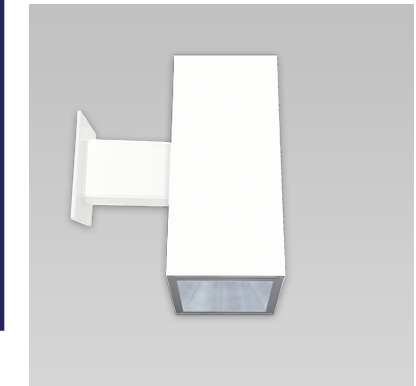

LWC-07SDI

7"x18" Up/Down 1500-5000L



LWC-09RDI

9"x19" Cylinder 1500-5000L

LWC-03RDI: 3" x 12" Direct/Indirect



- Up to 2,041 delivered lumens either direction (direct/indirect)
- Up to 3,931 delivered lumens as LSC-03RDN (downlight only)
- Optional "Weather Cap" for wet location listing
- Optional ADA-compliant mounting arm (<4" standoff)

Choose from 3 Mix-and-Matchable Beam Distributions

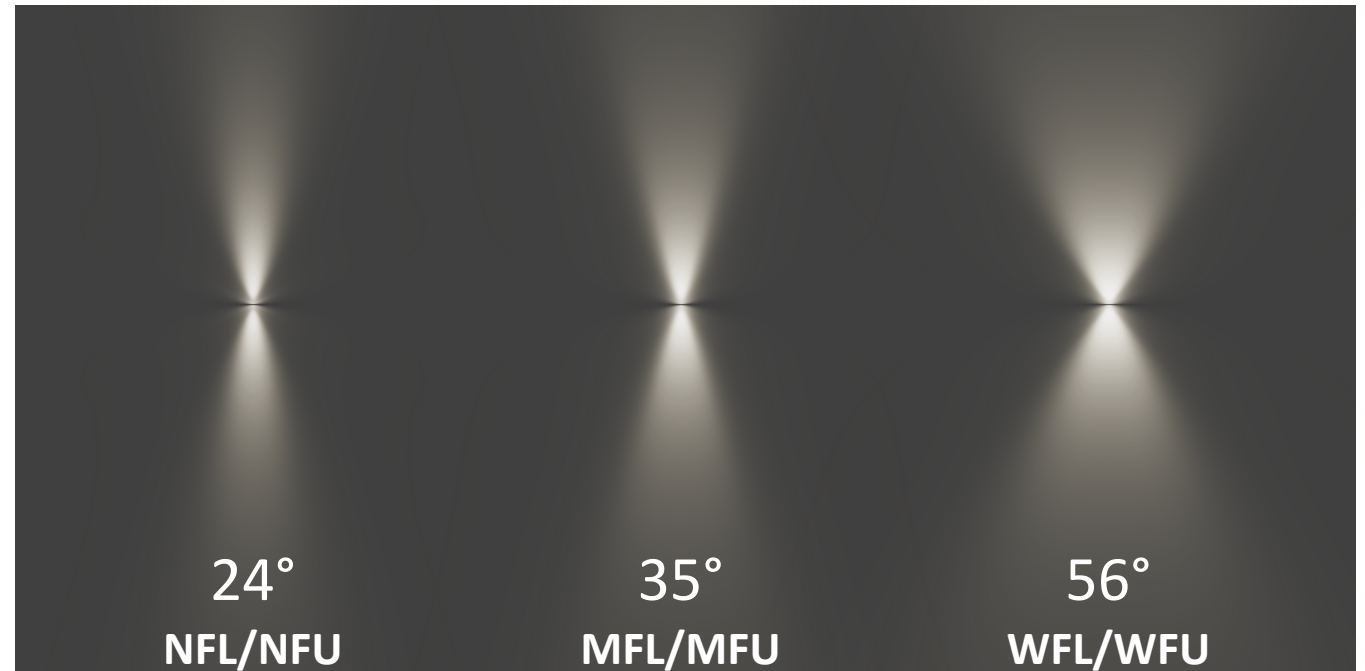

Downlight Cylinders



LSC-03RDN

3"x12" Cylinder 1000-4000L



LSC-06RDN

6"x15" Cylinder 1000-5000L



LSC-07SDN

7"x18" Square 2000-7000L



LSC-09RDN

9"x16" Cylinder 2000-7000L



LSC-11RDN

11"x18" Cylinder 3,000-10,500L



LSC-12RSD

12"x4" Cylinder 1000-4000L



LSC-13SDN

13"x9" Square 1000-7000L



LSC-14DLD

14"x8" Square 1000-7000L

Direct/Indirect

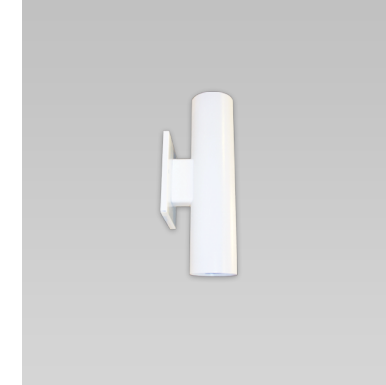

LWC-03RDI

3"x12" Up/Down 1000-2000L



LWC-06RDI

6"x18" Up/Down 1000-3500L

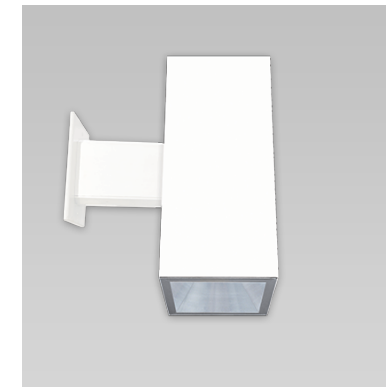

LWC-07SDI

7"x18" Up/Down 1500-5000L



LWC-09RDI

9"x19" Cylinder 1500-5000L

LSC-12RSD: 12" x 4" Super Shallow Downlight



CATALOG #	TYPE	
JOB NAME	WATTAGE	VOLTAGE

Choice Series

Super Shallow 12" Cylinder • High Output • COB LED
 60,000 Hours • 1% Dimming, 0-10V
 3 Step Binning • Wet Listed • LM-80 and LM-79 Certified

LSC-12RSD



Specifications

Delivered System Performance

- Lumen Series: **Must Specify**
 - 4000L
 - 3000L
 - 2500L
 - 2000L
 - 1500L
 - 1000L
- Select trim & beam distribution: see chart
- Select color (CCT): see chart; 80+ CRI standard; Option -HC for 90+ (15% lumen loss)
- 60,000 hour life

Thermal Management System

- All aluminum heat sink and components for cool operation, long life, low maintenance

LED Driver - INTERNAL

- Indoor/Outdoor: -30°C to 60°C (22°F to 140°F)
- 0-10V CCR 1% dimming standard
- Voltage Options: **Must Specify**
 - UNV - 120-277V (50-60Hz); load insensitive
 - 120 - 120V input (50-60Hz); for -D6, -29 only

Trim Assembly

- Seamless white self-flanged aluminum
- Tempered clear microprismatic lens
- Molded reflector system
- Option -DA for diffuse acrylic lens
- Option -WA for white acrylic lens
- Option -13 for clear polycarbonate overlay
- Option -26 for vandal resistant hardware

Aluminum Housing

- Seamless white acrylic enameled finish
- Rustproof: Exceeds 1000 hour ASTM 5% salt spray test
- Water-tight construction with weatherproof closed cell top gasket for wet location use
- No visible cylinder hardware
- Cool operation: Extends life of all components
- Fully sustainable: Entire luminaire is modular, easily visible, and serviced through aperture
- See Options for additional finishes and mounts

Installation

- Direct mount to any J-box pattern
- Indoor or outdoor
- Option -PM for pendant mount

UL, C-UL (Canada), & FCC Compliance

- Wet listed in surface or pendant mount
- FCC Part 15 certified for EMI/RFI emissions

FIVE YEAR Limited Warranty

- Complete standard fixture



Housing Finishes & Key Features

Housing Finish Options

**White
(Standard)**



Silver



**Dark
Bronze**



Black



Key Features

- Deep-drawn seamless aluminum enclosures
- No exposed air venting or heat sink hardware
- Low profile super-shallow “puck” for hard ceilings
- Wall bracket, rigid pendant, aircraft cable, cord, or surface mounting options

Choice Series

Choice Series ARCHITECTURAL LED LIGHTING

RECESSED

- Timeless Classics**: Includes circular and square recessed fixtures. Specifications: SHAPE (Circular, Square), LUMENS (1000L, 1500L, 2000L, 2500L, 3000L, 4000L Type IC, 5000L, 6000L, 7000L), COLOR TEMP (27K, 30K, 35K, 40K, 50K), CRI (80+, 90+), BEAM (20° SPT, 40° NFL, 50° MFL, 70° WFL).
- Speciality Luminaires**: Includes various circular and square recessed fixtures. Features icons for IK10, VR, IP65, IP66, and 100.

SURFACE MOUNTED

- Cylinders & Squares**: Includes cylindrical and square surface-mounted fixtures. Specifications: SHAPE (Cylindrical, Square), LUMENS (1000L, 1500L, 2000L, 2500L, 3000L, 4000L, 5000L, 6000L, 7000L, 8500L, 10500L), COLOR TEMP (27K, 30K, 35K, 40K, 50K), CRI (80+, 90+), BEAM (20° SPT, 40° NFL, 50° MFL, 70° WFL).
- Direct/Indirect Luminaires**: Includes various cylindrical and square surface-mounted fixtures.

RECESSED

SURFACE

Join us in Detroit for Healthcare CEU Course

Best Practices: Lighting the Modern Hospital

AIA/NCQLP Accredited Seminar
8 CEU Credits; 1.5 Days at Kirlin Factory

October 14-15, 2021
(Thursday-Friday)

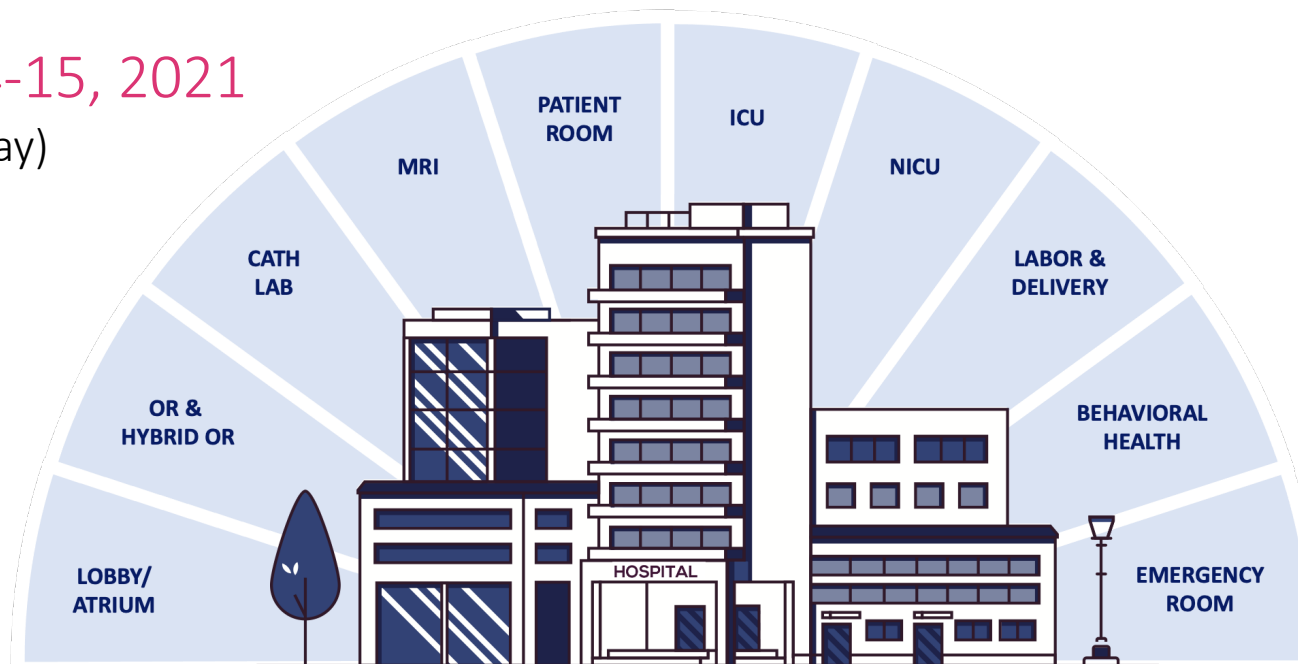



Questions?