

LATITUDES

Recessed • Surface • Pendant • Wall Mount

1000L • 1500L • 2000L • 2500L • 3500L • 5000L • 6500L

with **KIRLIN** *Select*



Denver Union Station. Lighting Design: Clanton & Associates
KIRLIN LED Luminaires: LSR-06473; LWR-09496





















Architectural LED Lighting

Downlight • Adjustable • Wall Wash • Super Shallow • Type IC / Wet
Shower / Sauna / Steam • IP65 / 66 • Clean Room • Ligature / Vandal Resistant
Color Specific • Xicato® • NightLights • StepLights

Lighting Innovators Since 1895

SEARCH BY DESIGN AND APPLICATION

To search for products by product number see pages 4-5.

				Delivered Lumens	
				1000 - 2000	2500 - 6500
				Page	Page
Recessed	Round	Downlights	Open Appearance	10	13
			Lensed	10-11, 16-17	13, 15-17
			Super Shallow/Shallow	10, 28-30	13, 15
			Shower Lights	11	15
			NEW! Sauna/Steam Room  	11	
			NEW! IP65 	16	16-17
			NEW! IP66  	11	16
			Vandal Resistant	17	17
			NEW! Ligature / Vandal Resistant	30	
			NEW! Cleanroom   		17
	NEW! Color Specific	17			
	NEW! Quickship - Gazelle  	28			
	Adjustables	12	13-14		
	Wall Washes		14		
	Type IC 	10-12, 16-17 28-30			
	NEW!  Integrated Module 	29-30			
	XICATO® 	32	32		
	NightLights and StepLights	35			
	Square	Downlights	Open Appearance	22-23, 28, 30	23
			Lensed	22-23	23, 25
			Super Shallow/Shallow	22, 28, 30	23, 25
			NEW! Quickship - Gazelle  	28	
		Adjustables	22	24	
		Wall Washes	23	24	
		Type IC 	22-23, 28, 30		
		NEW!  Integrated Module 	30		
		XICATO® 	33	33	
NightLights and StepLights		35			

SEARCH BY DESIGN AND APPLICATION

To search for products by product number see pages 4-5.

				Delivered Lumens		
				1000 - 2000	2500 - 6500	
				Page	Page	
Surface*	Round	Downlights NEW! NEW!	Open Appearance		18 - 19	
			Lensed	18, 20, 31	18 - 20	
			Super Shallow	20, 31	20	
			Vandal Resistant	20	20	
	NEW!	Direct/Indirects (Wall Bracket)	KIRLIN Select Integrated Module	Flagpole (Indirect) (Wall Bracket)	20, 21	21
				Sconce	31	
				Downlights	34	
				Direct/Indirects (Wall Bracket)		26 - 27
				Sconce		27
				Sconce	34	
Kirlin Hallmarks: Value, Innovation, Selection, Dependability				6 - 9		
Options				28, 31, 33, 35		

*Optional Pendant, Cord, Wall Bracket Mounts - see submittal sheets for specifics and availability.

LED Luminaire Numbering Logic

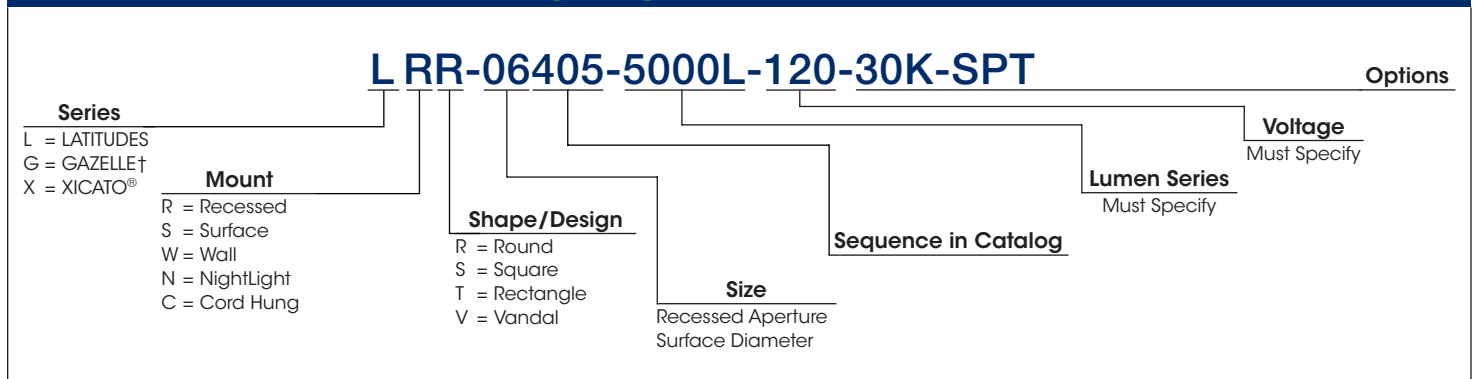

†QuickShip Line. See Gazelle Catalog.

- IP66 Rated
- Kirlin BioGard™ anti-microbial finish
- Type IC
- Chicago Plenum Approved
- IP65 Rated
- Gazelle Express version available, see reference list page 28.
- NSF Approved
- Meets ADA requirements
- Class 100 Cleanroom Rated
- Meets 60601-1-2 electromagnetic compatibility standard
- Meets Part 15 EMI/RFI emissions

Table of Contents - Search by Product Number



Search by the last three digits of the product number. (Listed in numerical order, based on last three digits.)

Product #	Description	Pg	Product #	Description	Pg	Product #	Description	Pg
LRR-04002 -2000L	Round Downlights	10	LRS-04045 -2000L	Square Downlights	22	LNV-07126	Security NightLight	35
LRR-04002 -1500L			LRS-04045 -1500L			* LRR-04137 -2000L	Round Wall Washes	30
LRR-04002 -1000L			LRS-04045 -1000L			* LRR-04137 -1500L		
LRR-06003 -2000L			LRS-04046 -1500L			* LRR-04137 -1100L		
LRR-06003 -1500L			LRS-04046 -1000L			* LRR-06139 -2000L	Round Wall Washes	30
LRR-06003 -1000L			LRS-02047 -2000L			* LRR-06139 -1500L		
LRR-04005 -2000L			LRS-02047 -1500L			* LRR-06139 -1100L		
LRR-04005 -1500L			LRS-02047 -1000L			* LRS-04142 -2000L	Square Downlights	30
LRR-04005 -1000L			LRS-04057 -2000L			* LRS-04142 -1500L		
LRR-04006 -1500L			LRS-04057 -1500L			* LRS-04142 -1100L		
LRR-04006 -1000L	Round Super Shallow		LRS-04057 -1000L	Square Adjustables		LSR-14150	Sconces	34
LRR-02007 -2000L	Round Downlights	LRS-02062 -2000L						
LRR-02007 -1500L		LRS-02062 -1500L						
LRR-02007 -1000L		LRS-02062 -1000L						
LRR-05010 -2000L	Shower Lights		LRS-04072 -2000L	Square Wall Washes	23	* LSR-06173 -1100L	Round Super Shallow Surface Cylinders	31
LRR-05010 -1500L			LRS-04072 -1500L					
LRR-05010 -1000L			LRS-04072 -1000L					
* LRR-06013 -750L	Sauna / Steam Room		LNR-05076	NightLights & StepLights	35	* LWR-06191 -2000L	Direct / Indirect Cylinders	
LRR-04017 -2000L	Round Lensed Downlights	11	LNR-05077					
LRR-04017 -1500L			LNR-05081					
LRR-04017 -1000L			* LRS-06085 -2000L					
LRR-06018 -2000L			* LRS-06085 -1500L					
LRR-06018 -1500L			* LRS-06085 -1000L					
LRR-06018 -1000L			LNS-05086					
LRR-06019 -2000L			LNS-05087					
LRR-06019 -1500L			LNT-03091					
LRR-06019 -1000L			LNT-03092					
* LRR-06020 -2000L			IP66 / NSF Round Downlights		LNT-03096			
* LRR-06020 -1500L	LNT-03098							
* LRR-06020 -1000L	LNT-07101							
LRR-04022 -2000L	Round Adjustables	12	LNT-07102	Round Downlights	29	XRR-04301 -3000L	XICATO® Round Downlights	
LRR-04022 -1500L			* LRR-04102 -2000L					
LRR-04022 -1000L			* LRR-04102 -1500L					
LRR-02027 -2000L			* LRR-04102 -1100L					
LRR-02027 -1500L			* LRR-06103 -2000L					
LRR-02027 -1000L			* LRR-06103 -1500L					
LRR-06030 -2000L			* LRR-06103 -1100L					
LRR-06030 -1500L			* LRR-04105 -2000L					
LRR-06030 -1000L			* LRR-04105 -1500L					
LRR-04037 -2000L			* LRR-04105 -1100L					
LRR-04037 -1500L	LRR-05110 -2000L	Shower Lights		30	LRR-06405 -5000L	Round Downlights	13	
LRR-04037 -1000L	LRR-05110 -1500L							
LRR-06039 -2000L	LRR-05110 -1100L							
LRR-06039 -1500L	* LRR-06120 -2000L	IP66 Downlight						
LRR-06039 -1000L	* LRR-06120 -1500L							
LRS-04042 -2000L	* LRR-06120 -1100L							
LRS-04042 -1500L	Square Downlights	22	* LRV-06121 -2000L	Ligature / Vandal Resistant		LRR-07410 -6500L		
LRS-04042 -1000L			* LRV-06121 -1500L			LRR-07410 -5000L		
			* LRV-06121 -1100L			LRR-07410 -3500L		
						LRR-07410 -2500L		
						* LRR-04413 -2500L	Round Adjustable	

* = New Product

Table of Contents - Search by Product Number

Search by the last three digits of the product number. (Listed in numerical order, based on last three digits.)

Product #	Description	Pg	Product #	Description	Pg	Product #	Description	Pg
LRR-06415 -5000L	Round Adjustables	14	LRV-07469 -2000L	Vandal Resistant IP65 Rounds	17	LWR-09492 -3500L	Direct / Indirect Cylinders	21
LRR-06415 -3500L			LRV-07469 -1500L			LWR-09492 -2500L		
LRR-06415 -2500L			LRV-07469 -1000L			LWR-09496 -3500L		
LRR-07420 -6500L			LRV-08470 -6500L	Vandal Resistant Round Downlights		LWR-09496 -2500L	Shallow Square Downlights	
LRR-07420 -5000L			LRV-08470 -5000L			LRS-04500 -2500L		
LRR-07420 -3500L			LRV-08470 -3500L			LRS-04503 -2500L		
LRR-07420 -2500L			LRV-08470 -2500L	Color Specific		LRS-06505 -6500L	Square Downlights	
* LRR-04423 -2500L	* LRR-08471 -465	LRS-06505 -5000L						
LRR-06425 -5000L	* LRR-08471 -590	LRS-06505 -3500L						
LRR-06425 -3500L	Round Wall Washes	14	* LRR-08471 -660	Round Cord / Surface Downlights	18	LRS-06505 -2500L	Square Adjustables	23
LRR-06425 -2500L			* LCR-03472 -1500L			* LRS-06507 -2500L		
LRR-07430 -6500L			LSR-06473 -1500L			LRS-04508 -2500L		
LRR-07430 -5000L			LSR-06473 -1000L			LRS-06510 -6500L		
LRR-07430 -3500L			LSR-09479 -6500L			LRS-06510 -5000L		
LRR-07430 -2500L			LSR-09479 -5000L			LRS-06510 -3500L		
LRR-05435 -2500L			Shower Light			LSR-09479 -3500L		
LRR-05438 -2500L	Round Super Shallow	LSR-09479 -2500L	LRS-04515 -2500L					
LRR-05440 -2500L		LSR-09480 -6500L	Square Wall Washes					
LRR-06445 -6500L	Round Downlights	15		LSR-09480 -5000L	Round Surface Downlights	19	LRS-06520 -6500L	Square Lensed Downlights
LRR-06445 -5000L			LSR-09480 -3500L	LRS-06520 -5000L				
LRR-06445 -3500L			LSR-09480 -2500L	LRS-06520 -3500L				
LRR-06445 -2500L			LSR-12481 -6500L	LRS-06520 -2500L				
LRR-06450 -6500L			LSR-12481 -5000L	LRS-08525 -2500L				
LRR-06450 -5000L			LSR-12481 -3500L	LRS-10526 -5000L				
LRR-06450 -3500L			LSR-12481 -2500L	LRS-10526 -3500L				
LRR-06450 -2500L	LSR-12482 -6500L	LRS-08530 -6500L	Square Surface Downlights					
* LRR-06453 -2500L	LSR-12482 -5000L	LRS-08530 -5000L						
LRR-07455 -6500L	LSR-12482 -3500L	LRS-08530 -3500L						
LRR-07455 -5000L	IP66 / NSF	16	LSR-12482 -2500L	Round Surface Adjustables	19	LRS-08530 -2500L	Square Surface Downlights	26
LRR-07455 -3500L			LSR-12483 -6500L			LRS-11535 -6500L		
LRR-07455 -2500L			LSR-12483 -5000L			LSS-07540 -2500L		
LRR-07460 -6500L			LSR-12483 -3500L			LSS-07545 -2500L		
LRR-07460 -5000L			LSR-12483 -2500L			LSS-07550 -6500L		
LRR-07460 -3500L			LSR-12484 -2000L			LSS-07550 -5000L		
LRR-07460 -2500L			LSR-12484 -1500L			LSS-07555 -5000L		
LRR-04462 -2000L	Round Surface Super Shallow	16	LSR-12484 -1000L	Round Surface Lensed	20	LSS-07555 -3500L	(Optional Pendant or Wall Bracket)	
LRR-07462 -1500L			* LSR-12486 -2500L			LSS-13560 -6500L		
LRR-07462 -1000L			LSV-12487 -2000L			LSS-13560 -5000L		
LRR-08464 -6500L			LSV-12487 -1500L			LSS-13560 -3500L		
LRR-08464 -5000L			LSV-12487 -1000L			LSS-13565 -6500L		
LRR-08464 -3500L			* LSV-12488 -2500L			LSS-13565 -5000L		
LRR-08464 -2500L			* LWR-03489 -1500L			LSS-13565 -3500L		
LRR-08466 -6500L	Cleanroom IP65	17	LWR-09490 -6500L	Flagpole Wall Bracket	21	LSS-14570 -6500L	Direct / Indirect Squares	
LRR-08466 -5000L			LWR-09490 -5000L			LWS-07575 -3500L		
LRR-08466 -3500L			LWR-09490 -3500L			LWS-07575 -2500L		
LRR-08466 -2500L	Vandal Resistant IP65	17	* LWR-06491 -2000L	Direct / Indirect Cylinders	21	LWS-07580 -3500L		
LRV-08468 -6500L			* LWR-06491 -1500L			LWS-07580 -2500L		
LRV-08468 -5000L			* LWR-06491 -1000L					
LRV-08468 -3500L								
LRV-08468 -2500L								

* = New Product

Since 1895 Kirlin’s passion and focus has been to deliver outstanding **VALUE**, true **INNOVATION**, superior **SELECTION**, and steadfast **DEPENDABILITY** to its customers.

VALUE Exceeding Expectations

QUALITY

Superior materials, American craftsmanship and sophisticated performance distinguish KIRLIN luminaires from all others. Every luminaire is photometered by independent testing experts, is UL/C-UL listed for wet locations, covered ceilings, and tested before shipment to ensure unparalleled quality assurance for the life of the installation.

SUSTAINABILITY

Every luminaire, featuring modular design and QuickConnect™ wiring, is easily serviced through the aperture, ensuring the greatest return on your investment.

With **KIRLIN Select** you receive exclusive Integrated Module Technology (IMT). IMT features an ultra high efficacy (> 95 LPW) lighting module. This module contains the LED lighthouse, heatsink and driver in a single compact package. Superior quality of light results from 3 step binning for color consistency from fixture to fixture. Rustproof and corrosion proof shallow 4-3/8” all aluminum housing ensures cool operation and long life. Kirlin QuickConnect™ wiring simplifies service and the entire recessed luminaire is accessible and visible through the trim aperture.

RELIABILITY

Our luminaires are rustproof, lightweight, cool operating and corrosion resistant. Life of our lights is extended beyond driver/LED reported life. KIRLIN may be installed in challenging environments with assurance: wet, sauna/steam, salt air, infection control, cleanroom or vandal resistant.



INNOVATION Better Solutions

DESIGN

Each luminaire is designed for exceptional optical control which maximizes visual comfort, efficiency and specification sophistication, while providing up to 4 unique beam spreads:

10° - SPT	0.1 - 0.3 SC
25° - NFL	0.4 - 0.5 SC
40° - MFL	0.6 - 0.8 SC
80° - WFL	0.9 - 1.4 SC

Color temperature choices: 3500°K (std), 2700°K (Option -27K), 3000°K (Option -30K), 4100°K (Option -41K) and 5000°K (Option -50K).

Color rendering choices: 80+ CRI (std) or with Option -HC, 90+ CRI or 95+ CRI (Artist® Series).

Adjustables tilt up to 45° and rotate 360°.

Seamless cylinders with attractive proportions from 3" - 12" diameters.

ENERGY EFFICIENCY

High performance LEDs deliver excellent color plus energy efficiency, providing 90,000 hour life (L70) max.

Up to 105 delivered lumens per system watt. For -2000L, -1500L, -1300L, -1100L, -1000L and -750L series, Type IC and Wet Location is standard, Air Tight optional (Option -AT).

XICATO® Series offers COB benefits with constant color in small apertures.

For remote dimming driver expertise (down to 0.1%) see:

- Sauna/Steam Light, page 11
- KIRLIN Symphony Series
- KIRLIN SmartLED™ MRI Lighting Systems

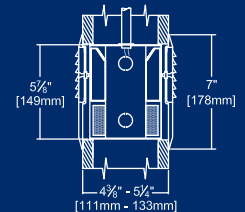

SELECTION Creative Freedom

LUMEN PACKAGES

Ten light engines deliver precise lumen packages with multiple spacing criteria, enabling optimal selection of energy efficient lighting for each unique project.

TRIM STYLES

Timeless visual appeal is provided in every luminaire from 2" pinholes to 8" lensed high lumen designs, in complete families of round and square anodized specular, SofTex™ or acrylic enameled trim finishes. Custom paint colors (Option -94) available throughout our collection. Sconces include customized central logo field.

Dead front shower lights, sauna/steam light, IP65 infection protection, IP66 intrusion protection, BioGard™ anti-microbial finish, vandal resistant and anti-ligature trim designs are offered.

DESIGNS

Downlights, adjustables, wall washes, direct/indirect, sconces, nightlights and steplights.

Recessed, surface, pendant, wall bracket, cable mount and flagpole.

Shallow and super shallow recessed and surface.

APPLICATIONS

Indoor and outdoor, wet locations, IP65, IP66, NSF, cleanroom (ISO 5 Class 100 sealed), shower, sauna/steam, color specific, canopy, vandal resistant and maximum security.

Ratings include: Type IC; Wet Location, IP65; NSF; IP66; ISO 5 Class 100 Sealed Cleanroom; IEC/EN 60601-1-2; FCC Part 15; City of Chicago Environmental Air (CCEA); ADA.

Thru-the-wall NightLight illuminates two rooms from one fixture. Optional fastener-free NightLights and StepLights offer a sleek, modern appearance.

OPTIONS

Many popular and application enhancing options are available including dimming methods and range, color temperatures, color rendering, spacing criteria, emergency battery packs, trims, lenses, colors/finishes and mountings.

Option -99 for special modifications.

For additional details, see submittals at www.kirlinlighting.com.



DEPENDABILITY Peace of Mind

- EXPERTISE** Lighting innovation since 1895.

- VERIFICATION** Photometric performance for each light engine and each beam spread is verified from ITL, Boulder, CO or UL Verification Services, Allentown, PA.

Independent LM-79 certified photometry and LM-80 qualified LEDs, consistent LED color: Within 3 MacAdam Ellipse or 2 MacAdam Ellipse (XICATO®).

- AWARD WINNING** Recipient of Architectural SSL Product Innovation Awards and IESNA Progress Awards.

- CUSTOMER SERVICE** Responsive, knowledgeable and dedicated.

- WARRANTY** Superior protection from Kirlin's 5 Year Limited Warranty: Complete luminaire with driver.

- LONGEVITY** Replacement components are available for years into the future. Modular design minimizes field service time and cost.

LATITUDES Dimming & Control Options

KIRLIN OPTION	DESCRIPTION	PROFILE
-29	Two wire full range (100-1%) PWM dimming	Lutron
-D1	0-10V (100-1%) dimming	Linear ¹
-D2	0-10V (100-0.1%) dimming	Linear ¹
-D3	DALI (100-1%) dimming	Logarithmic ²
-D4	DALI (100-0.1%) dimming	Logarithmic ²
-D5	DMX512A (100-0%) dimming	Linear ¹
-ECO	Digital driver for EcoSystem controls	Lutron

¹ Linear dimming profiles are most common and suitable for general dimming applications.

² Logarithmic dimming profiles enhance low level dimming, smoothness and adjustability.



**ARRA
QUALIFIED**



Designed, manufactured and assembled in the United States

4"

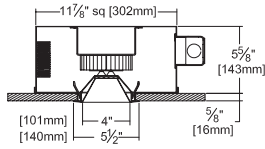
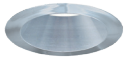

LRR-04002-2000L
LRR-04002-1500L
LRR-04002-1000L



-1500L SERIES PERFORMANCE

1538 LUMENS

20.9W

MFL (STD)

SC: 0.8

LPW: 74

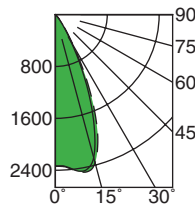

Cone of Light ▲

Dist.	FC	Dia.
6	64.9	4.9
8	36.5	6.6
10	23.4	8.2
12	16.2	9.9
14	11.9	11.5
16	9.1	13.2

-SPT -NFL -WFL

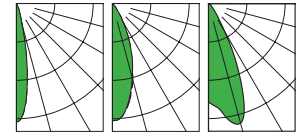

Lm: 1629 SC: 0.3 Lm: 1428 SC: 0.6 Lm: 1538 SC: 0.9

6"

Downlights

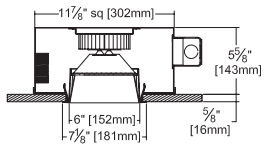

LRR-06003-2000L
LRR-06003-1500L
LRR-06003-1000L



-2000L SERIES PERFORMANCE

2140 LUMENS

25.6

MFL (STD)

SC: 0.8

LPW: 84

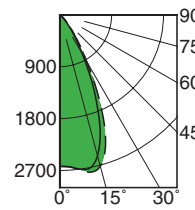

Cone of Light ▲

Dist.	FC	Dia.
6	73.0	5.3
8	41.1	7.1
10	26.3	8.8
12	18.3	10.6
14	13.4	12.4
16	10.3	14.1

-SPT -NFL -WFL

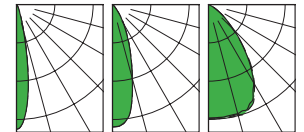

Lm: 2145 SC: 0.3 Lm: 1996 SC: 0.6 Lm: 1855 SC: 1.2

4"

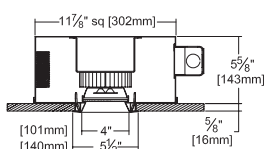

LRR-04005-2000L
LRR-04005-1500L
LRR-04005-1000L



-1500L SERIES PERFORMANCE

1685 LUMENS

21.0W

MFL (STD)

SC: 0.7

LPW: 80

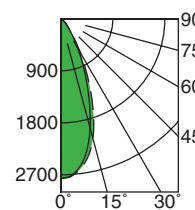

Cone of Light ▲

Dist.	FC	Dia.
6	76.6	4.1
8	43.1	5.5
10	27.6	6.8
12	19.2	8.2
14	14.1	9.6
16	10.8	11.0

-NFL -WFL

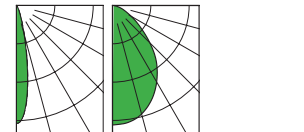

Lm: 1800 SC: 0.4 Lm: 1363 SC: 1.1

4"

Super Shallow

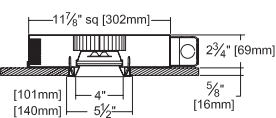

LRR-04006-1500L
LRR-04006-1000L



-1500L SERIES PERFORMANCE

1685 LUMENS

21.0W

MFL (STD)

SC: 0.7

LPW: 80

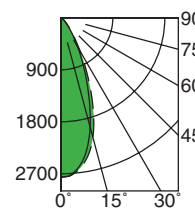

Cone of Light ▲

Dist.	FC	Dia.
6	76.6	4.1
8	43.1	5.5
10	27.6	6.8
12	19.2	8.2
14	14.1	9.6
16	10.8	11.0

-NFL -WFL

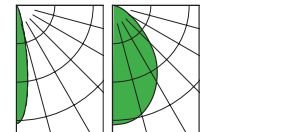

Lm: 1800 SC: 0.4 Lm: 1363 SC: 1.1

2"

Downlight

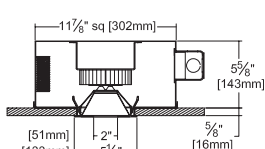

LRR-02007-2000L
LRR-02007-1500L
LRR-02007-1000L



-1500L SERIES PERFORMANCE

1253 LUMENS

20.8W

NFL

SC: 0.3

LPW: 60

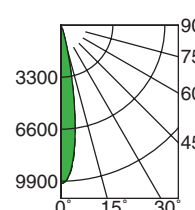

Cone of Light ▲

Dist.	FC	Dia.
6	278.9	2.0
8	156.9	2.7
10	100.4	3.3
12	69.7	4.0
14	51.2	4.7
16	39.2	5.3

5" Shower Light



LRR-05010-2000L
LRR-05010-1500L
LRR-05010-1000L

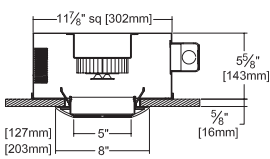

1078 LUMENS
20.9W
MFL
SC: 0.7
LPW: 52

-1500L SERIES PERFORMANCE

Cone of Light ▲

Dist.	FC	Dia.
6	17.9	4.5
8	10.1	5.9
10	6.5	7.4
12	4.5	8.9
14	3.3	10.4
16	2.5	11.9

▲ **Cone of Light Key**
Dist. Distance from fixture
FC Footcandles at nadir (0°)
Dia. Circle of light at 50% of FC
Dia. (in ft.) shown is where FC value is half the FC at nadir.

6" Sauna / Steam

NEW!



LRR-06013-750L

TO REM-0700A REMOTE DRIVER (SOLD SEPARATELY - SEE REM-0700A)

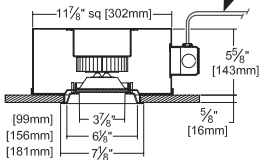

791 LUMENS
9.1W
WFL (STD)
SC: 0.9
LPW: 88

-750L SERIES PERFORMANCE

Cone of Light ▲

Dist.	FC	Dia.
6	20.7	3.2
8	11.6	4.3
10	7.5	5.4
12	5.2	6.5
14	3.8	7.6
16	2.9	8.7

Requires remote driver REM-0700A. Order separately. Up to 3 luminaires per driver.

IP66  NSF

-NFL & -MFL ALSO AVAILABLE

4" Downlights



LRR-04017-2000L
LRR-04017-1500L
LRR-04017-1000L

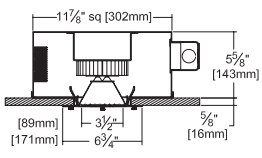

1429 LUMENS
21.0W
MFL (STD)
SC: 0.7
LPW: 68

-1500L SERIES PERFORMANCE

Cone of Light ▲

Dist.	FC	Dia.
6	47.4	4.5
8	26.7	6.0
10	17.1	7.6
12	11.9	9.1
14	8.7	10.6
16	6.7	12.1

-WFL

Lm: 1214
SC: 0.8

6" Downlights



LRR-06018-2000L
LRR-06018-1500L
LRR-06018-1000L

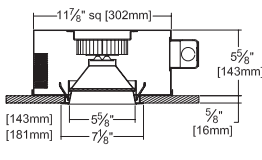

1721 LUMENS
20.8W
MFL (STD)
SC: 0.8
LPW: 83

-1500L SERIES PERFORMANCE

Cone of Light ▲

Dist.	FC	Dia.
6	67.3	4.9
8	37.8	6.6
10	24.2	8.2
12	16.8	9.9
14	12.4	11.5
16	9.5	13.2

-SPT Lm: 1744 SC: 0.3
-NFL Lm: 1553 SC: 0.6
-WFL Lm: 1514 SC: 1.1

6" Downlights



LRR-06019-2000L
LRR-06019-1500L
LRR-06019-1000L

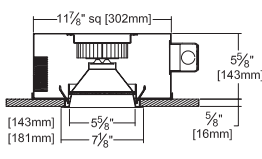

1721 LUMENS
20.8W
MFL (STD)
SC: 0.8
LPW: 83

-1500L SERIES PERFORMANCE

Cone of Light ▲

Dist.	FC	Dia.
6	67.3	4.9
8	37.8	6.6
10	24.2	8.2
12	16.8	9.9
14	12.4	11.5
16	9.5	13.2

-SPT Lm: 1744 SC: 0.3
-NFL Lm: 1553 SC: 0.6
-WFL Lm: 1514 SC: 1.1

6" IP66 Downlight

NEW!



LRR-06020-2000L
LRR-06020-1500L
LRR-06020-1000L

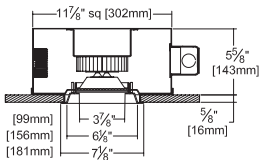

1366 LUMENS
18.2W
WFL (STD)
SC: 0.9
LPW: 75

-1500L SERIES PERFORMANCE

Cone of Light ▲

Dist.	FC	Dia.
6	35.7	5.6
8	20.1	7.5
10	12.9	9.4
12	8.9	11.2
14	6.6	13.1
16	5.0	15.0

-NFL Lm: 1358 SC: 0.4
-MFL Lm: 1273 SC: 0.6

IP66  NSF

4"

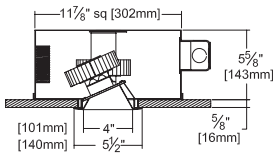
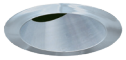

LRR-04022-2000L
LRR-04022-1500L
LRR-04022-1000L



-1500L SERIES PERFORMANCE

1564 LUMENS

20.8W

NFL (STD)

SC: 0.5

LPW: 75

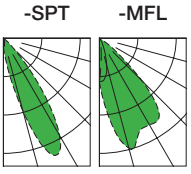
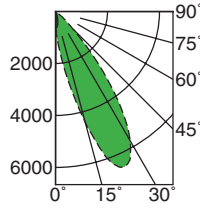

Lm: 1566 SC: 0.4 (SPT)
Lm: 1557 SC: 0.8 (MFL)

2"

Adjustables

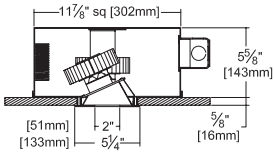

LRR-02027-2000L
LRR-02027-1500L
LRR-02027-1000L



-1500L SERIES PERFORMANCE

1102 LUMENS

21.0W

NFL

SC: 0.4

LPW: 53

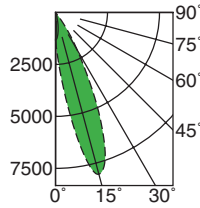

6"

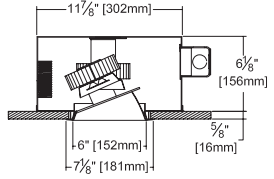
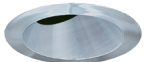

LRR-06030-2000L
LRR-06030-1500L
LRR-06030-1000L



-1500L SERIES PERFORMANCE

1508 LUMENS

21.0W

NFL (STD)

SC: 0.6

LPW: 72

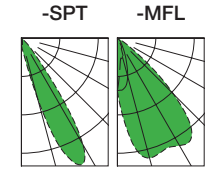
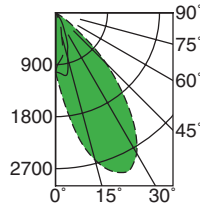

Lm: 1581 SC: 0.3 (SPT)
Lm: 1559 SC: 0.8 (MFL)

4"

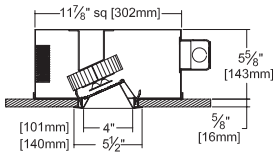
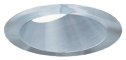

LRR-04037-2000L
LRR-04037-1500L
LRR-04037-1000L



-1500L SERIES PERFORMANCE

1375 LUMENS

20.8W

LPW: 66

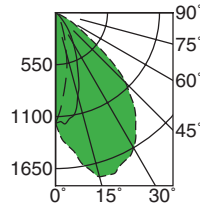

Wall Washes

6"

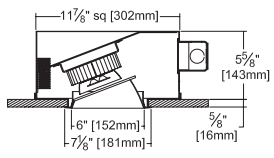
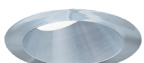

LRR-06039-2000L
LRR-06039-1500L
LRR-06039-1000L



-1500L SERIES PERFORMANCE

1508 LUMENS

21.0W

LPW: 72

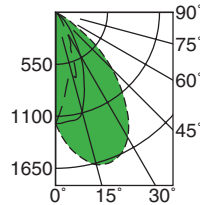

▲ Cone of Light Key
Dist. Distance from fixture
FC Footcandles at nadir (0°)
Dia. Circle of light at 50% of FC
Dia. (in ft.) shown is where FC value is half the FC at nadir.

4"

Shallow Downlights

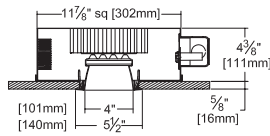

LRR-04400-2500L

-2500L SERIES PERFORMANCE

2838 LUMENS

36.4W
MFL (STD)
SC: 0.7
LPW: 78

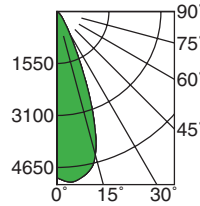

Cone of Light ▲

Dist.	FC	Dia.
6	138.0	4.4
8	77.4	5.9
10	49.5	7.3
12	34.4	8.8
14	25.3	10.3
16	19.4	11.7

-SPT

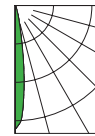

Lm: 2858
SC: 0.3

-NFL

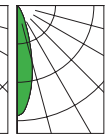

Lm: 2726
SC: 0.5

4"

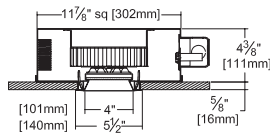

LRR-04403-2500L

-2500L SERIES PERFORMANCE

2800 LUMENS

36.4W
MFL (STD)
SC: 0.8
LPW: 77

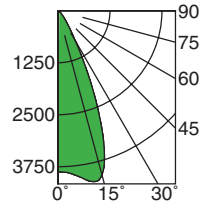

Cone of Light ▲

Dist.	FC	Dia.
6	107.0	5.0
8	60.5	6.6
10	38.7	8.3
12	26.9	9.9
14	19.7	11.6
16	15.1	13.2

-NFL

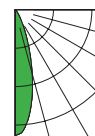

Lm: 2390
SC: 0.5

6"

Downlights

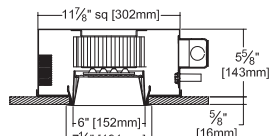

LRR-06405-5000L
LRR-06405-3500L
LRR-06405-2500L

-5000L SERIES PERFORMANCE

4892 LUMENS

57.2W
MFL (STD)
SC: 0.6
LPW: 86

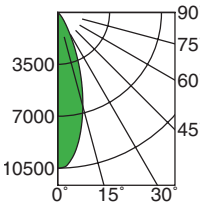

Cone of Light ▲

Dist.	FC	Dia.
6	292.7	3.5
8	164.6	4.7
10	105.4	5.9
12	73.2	7.1
14	53.8	8.3
16	41.2	9.5

-SPT

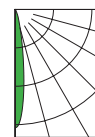

Lm: 4893
SC: 0.3

-WFL

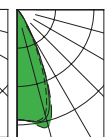

Lm: 4746
SC: 0.9

7"

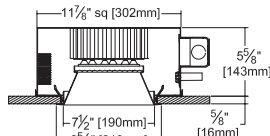

LRR-07410-6500L
LRR-07410-5000L
LRR-07410-3500L
LRR-07410-2500L

-6500L SERIES PERFORMANCE

5739 LUMENS

72.7W
MFL (STD)
SC: 0.7
LPW: 79

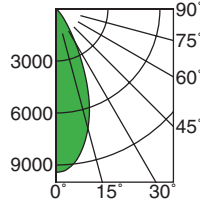

Cone of Light ▲

Dist.	FC	Dia.
6	262.1	4.3
8	147.4	5.8
10	94.4	7.2
12	65.5	8.6
14	48.1	10.1
16	36.9	11.5

-SPT

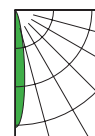

Lm: 6321
SC: 0.3

-WFL

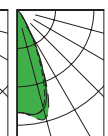

Lm: 6100
SC: 0.9

4"

NEW!

Adjustable

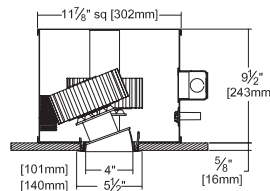

LRR-04413-2500L

-2500L SERIES PERFORMANCE

1952 LUMENS

34.3W
NFL (STD)
SC: 0.5
LPW: 57

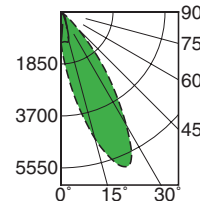

-SPT

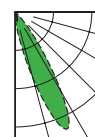

Lm: 2286
SC: 0.3

-MFL

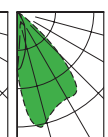

Lm: 2233
SC: 0.8

See Options on page 28

Adjustables

6"

pia
AWARD
WINNER

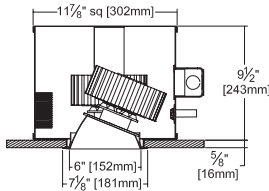

- LRR-06415-5000L
- LRR-06415-3500L
- LRR-06415-2500L

-5000L SERIES PERFORMANCE

4413 LUMENS

57.2W

NFL (STD)

SC: 0.6

LPW: 77

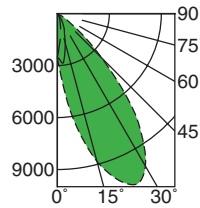

Cone of Light ▲

Dist.	FC	Dia.
6	175.1	5.2
8	98.5	6.9
10	63.1	8.6
12	43.8	10.3
14	32.2	12.0
16	24.6	13.7

-SPT

-MFL

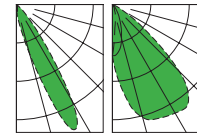

Lm: 4359
SC: 0.3

Lm: 4345
SC: 0.8

7"

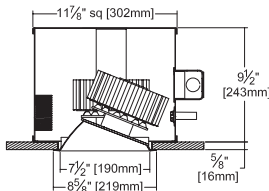

- LRR-07420-6500L
- LRR-07420-5000L
- LRR-07420-3500L
- LRR-07420-2500L

-6500L SERIES PERFORMANCE

5206 LUMENS

72.9W

NFL (STD)

SC: 0.6

LPW: 71

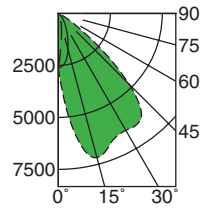

-SPT

-MFL

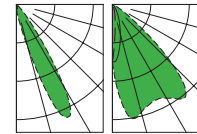

Lm: 5992
SC: 0.3

Lm: 5937
SC: 0.9

4"

NEW!

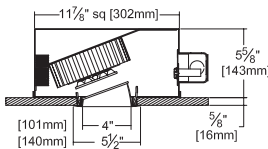
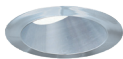

- LRR-04423-2500L

-2500L SERIES PERFORMANCE

2560 LUMENS

33.9W

LPW: 76

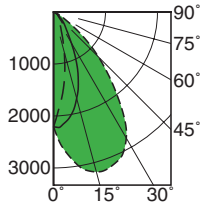

Wall Washes

6"

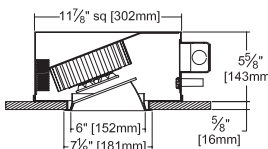

- LRR-06425-5000L
- LRR-06425-3500L
- LRR-06425-2500L

-5000L SERIES PERFORMANCE

4141 LUMENS

57.4W

LPW: 72

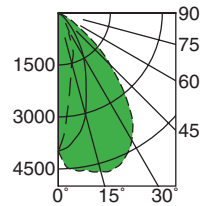

7"

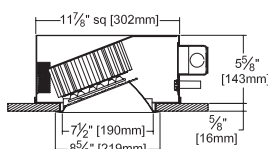

- LRR-07430-6500L
- LRR-07430-5000L
- LRR-07430-3500L
- LRR-07430-2500L

-6500L SERIES PERFORMANCE

5516 LUMENS

73.3W

LPW: 75

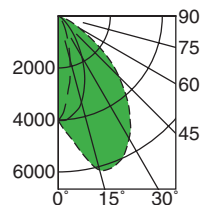

▲ Cone of Light Key

Dist. Distance from fixture
 FC Footcandles at nadir (0°)
 Dia. Circle of light at 50% of FC
 Dia. (in ft.) shown is where FC value is half the FC at nadir.

See Options on page 28

5"

Shower Light

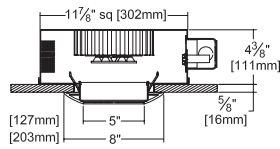

1878 LUMENS

34.9W

WFL

SC: 0.9

LPW: 54

-2500L SERIES PERFORMANCE

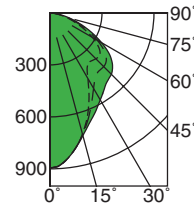

Cone of Light ▲

Dist.	FC	Dia.
6	24.9	5.4
8	14.0	7.2
10	9.0	8.9
12	6.2	10.7
14	4.6	12.5
16	3.5	14.3

LRR-05435-2500L

5"

Super Shallow

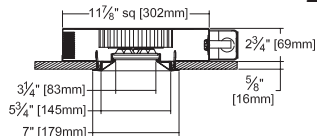

2753 LUMENS

36.9W

MFL

SC: 0.7

LPW: 75

-2500L SERIES PERFORMANCE

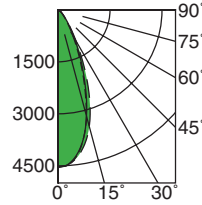

Cone of Light ▲

Dist.	FC	Dia.
6	126.1	4.1
8	70.9	5.4
10	45.4	6.8
12	31.5	8.1
14	23.2	9.5
16	17.7	10.8

LRR-05438-2500L

5"

Super Shallow

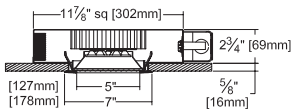

2409 LUMENS

36.8W

WFL

SC: 1.2

LPW: 66

-2500L SERIES PERFORMANCE

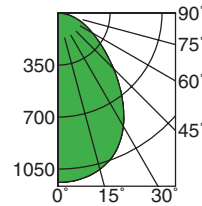

Cone of Light ▲

Dist.	FC	Dia.
6	31.6	6.9
8	17.8	9.3
10	11.4	11.3
12	7.9	13.9
14	5.8	16.2
16	4.5	18.5

LRR-05440-2500L

6"

Dowlinghts

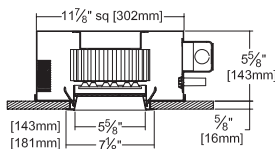

6076 LUMENS

73.1W

MFL (STD)

SC: 0.7

LPW: 83

-6500L SERIES PERFORMANCE

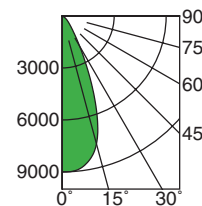

Cone of Light ▲

Dist.	FC	Dia.
6	250.1	4.5
8	140.7	6.0
10	90.0	7.5
12	62.5	9.1
14	45.9	10.6
16	35.2	12.1

-SPT

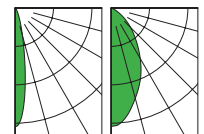

Lm: 6354
SC: 0.3

Lm: 5166
SC: 0.9

LRR-06445-6500L
LRR-06445-5000L
LRR-06445-3500L
LRR-06445-2500L

6"

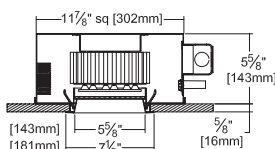

6076 LUMENS

73.1W

MFL (STD)

SC: 0.7

LPW: 83

-6500L SERIES PERFORMANCE

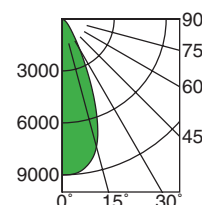

Cone of Light ▲

Dist.	FC	Dia.
6	250.1	4.5
8	140.7	6.0
10	90.0	7.5
12	62.5	9.1
14	45.9	10.6
16	35.2	12.1

-SPT

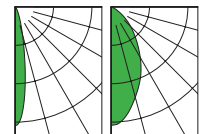

Lm: 6354
SC: 0.3

Lm: 5166
SC: 0.9

LRR-06450-6500L
LRR-06450-5000L
LRR-06450-3500L
LRR-06450-2500L

See Options on page 28

IP66 Downlight

6" **NEW!**

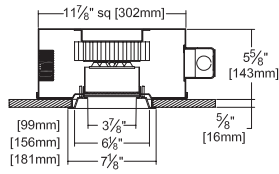

LRR-06453-2500L

-2500L SERIES PERFORMANCE

2590 LUMENS

72.9W

WFL (STD)

SC: 0.9

LPW: 78

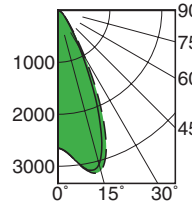

Cone of Light ▲

Dist.	FC	Dia.
6	73.7	5.5
8	41.4	7.3
10	26.5	9.1
12	18.4	11.0
14	13.5	12.8
16	10.4	14.6

-NFL -MFL

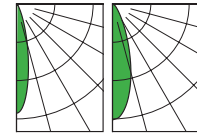

Lm: 2517 SC: 0.4 Lm: 2264 SC: 0.6

Downlights

7"

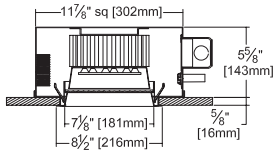

LRR-07455-6500L
LRR-07455-5000L
LRR-07455-3500L
LRR-07455-2500L

-6500L SERIES PERFORMANCE

6482 LUMENS

72.9W

MFL (STD)

SC: 0.8

LPW: 89

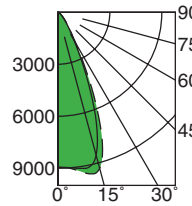

Cone of Light ▲

Dist.	FC	Dia.
6	248.5	4.9
8	139.8	6.5
10	89.5	8.1
12	62.1	9.7
14	45.6	11.3
16	34.9	12.9

-SPT -WFL

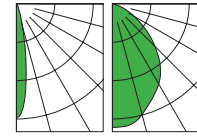

Lm: 6774 SC: 0.3 Lm: 5676 SC: 1.1

7"

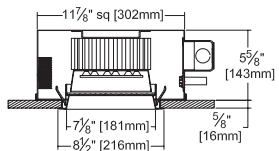

LRR-07460-6500L
LRR-07460-5000L
LRR-07460-3500L
LRR-07460-2500L

-6500L SERIES PERFORMANCE

6482 LUMENS

72.9W

MFL (STD)

SC: 0.8

LPW: 89

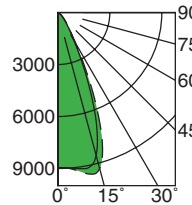

Cone of Light ▲

Dist.	FC	Dia.
6	248.5	4.9
8	139.8	6.5
10	89.5	8.1
12	62.1	9.7
14	45.6	11.3
16	34.9	12.9

-SPT -WFL

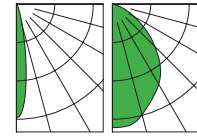

Lm: 6774 SC: 0.3 Lm: 5676 SC: 1.1

IP65

7"

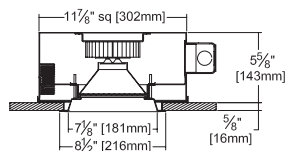

LRR-07462-2000L
LRR-07462-1500L
LRR-07462-1000L



-1500L SERIES PERFORMANCE

1721 LUMENS

20.8W

MFL (STD)

SC: 0.8

LPW: 83

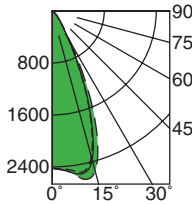

Cone of Light ▲

Dist.	FC	Dia.
6	67.3	4.9
8	37.8	6.6
10	24.2	8.2
12	16.8	9.9
14	12.4	11.5
16	9.5	13.2

-SPT -NFL -WFL

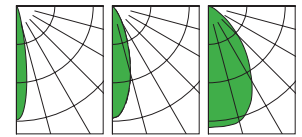

Lm: 1744 SC: 0.3 Lm: 1553 SC: 0.6 Lm: 1514 SC: 1.1

8"

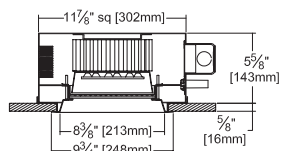

LRR-08464-6500L
LRR-08464-5000L
LRR-08464-3500L
LRR-08464-2500L



-6500L SERIES PERFORMANCE

6257 LUMENS

72.9W

MFL (STD)

SC: 0.8

LPW: 86

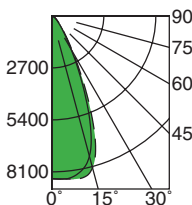

Cone of Light ▲

Dist.	FC	Dia.
6	234.9	4.8
8	132.1	6.4
10	84.6	8.0
12	58.7	9.6
14	43.1	11.1
16	33.0	12.7

-NFL -WFL

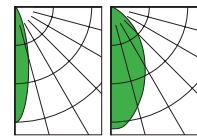

Lm: 6015 SC: 0.5 Lm: 5292 SC: 0.9

8"

Cleanroom IP65

IES
PROGRESS
REPORT
SELECTION



LRR-08466-6500L
LRR-08466-5000L
LRR-08466-3500L
LRR-08466-2500L





-6500L SERIES PERFORMANCE

6257 LUMENS

72.9W

MFL (STD)

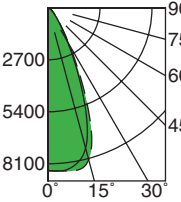
SC: 0.8
LPW: 86



Cone of Light ▲

Dist.	FC	Dia.
6	234.9	4.8
8	132.1	6.4
10	84.6	8.0
12	58.7	9.6
14	43.1	11.1
16	33.0	12.7

-NFL **-WFL**

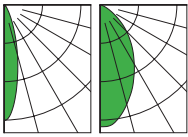

Lm: 6015 SC: 0.5 Lm: 5292 SC: 0.9

8"

Vandal Resist IP65



LRV-08468-6500L
LRV-08468-5000L
LRV-08468-3500L
LRV-08468-2500L





-6500L SERIES PERFORMANCE

5219 LUMENS

72.6W

MFL (STD)

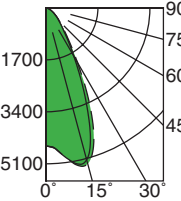
SC: 0.7
LPW: 72



Cone of Light ▲

Dist.	FC	Dia.
6	125.4	5.6
8	70.5	7.5
10	45.1	9.3
12	31.3	11.2
14	23.0	13.1
16	17.6	15.0

-NFL **-WFL**

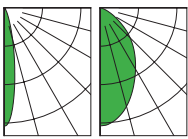

Lm: 5772 SC: 0.4 Lm: 5095 SC: 0.9

7"

Vandal Resist IP65



LRV-07469-2000L
LRV-07469-1500L
LRV-07469-1000L





-1500L SERIES PERFORMANCE

1495 LUMENS

20.9W

MFL (STD)

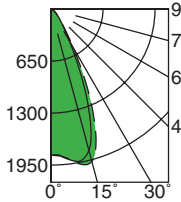
SC: 0.8
LPW: 72



Cone of Light ▲

Dist.	FC	Dia.
6	50.7	5.1
8	28.5	6.8
10	18.2	8.5
12	12.7	10.2
14	9.3	11.9
16	7.1	13.6

-SPT **-NFL** **-WFL**

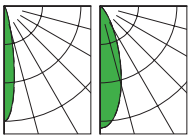

Lm: 1581 SC: 0.3 Lm: 1468 SC: 0.6 Lm: 1321 SC: 1.0

8"

Vandal Resistant



LRV-08470-6500L
LRV-08470-5000L
LRV-08470-3500L
LRV-08470-2500L



-6500L SERIES PERFORMANCE

5219 LUMENS

72.6W

MFL (STD)

SC: 0.7
LPW: 72

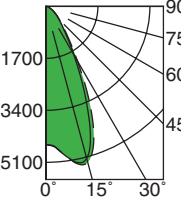

Cone of Light ▲

Dist.	FC	Dia.
6	125.4	5.6
8	70.5	7.5
10	45.1	9.3
12	31.3	11.2
14	23.0	13.1
16	17.6	15.0

-NFL **-WFL**

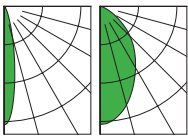

Lm: 5772 SC: 0.4 Lm: 5095 SC: 0.9

8"

Color Specific

NEW!

-465 Blue (Backstage Theatre 465nm)
-590 Yellow/Amber (Turtle Friendly 590nm)
-660 Red (Darkroom 660nm)



LRR-08471-465
LRR-08471-590
LRR-08471-660



-590: YELLOW/AMBER 590nm PERFORMANCE

906 LUMENS

20.9W

WFL

SC: 0.9
LPW: 45

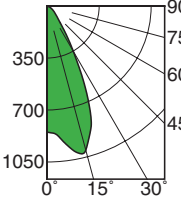

Cone of Light ▲

Dist.	FC	Dia.
6	23.6	3.0
8	13.2	4.3
10	8.5	5.0
12	5.9	6.0
14	4.3	6.9
16	3.3	8.0

▲ Cone of Light Key
Dist. Distance from fixture
FC Footcandles at nadir (0°)
Dia. Circle of light at 50% of FC

Dia. (in ft.) shown is where FC value is half the FC at nadir.

3"

NEW!

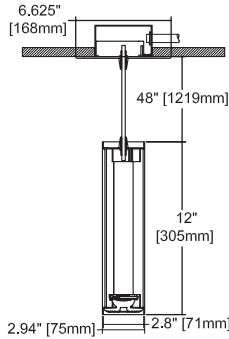

1420 LUMENS

18.5W

MFL (STD)

SC: 0.8

LPW: 77

-1500L SERIES PERFORMANCE

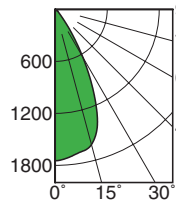

Cone of Light ▲

Dist.	FC	Dia.
6	48.5	5.3
8	27.3	7.1
10	17.5	8.8
12	12.1	10.6
14	8.9	12.4
16	6.8	14.1

-SPT

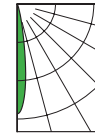

Lm: 1397
SC: 0.3

-NFL

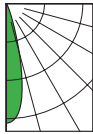

Lm: 1413
SC: 0.4

LCR-03472-1500L

Pendant and Wall Bracket Mounts Optional

6"

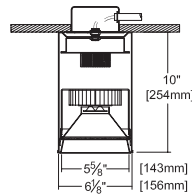

1721 LUMENS

20.8W

MFL (STD)

SC: 0.8

LPW: 83

-1500L SERIES PERFORMANCE

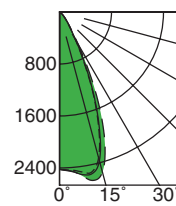

Cone of Light ▲

Dist.	FC	Dia.
6	67.3	4.9
8	37.8	6.6
10	24.2	8.2
12	16.8	9.9
14	12.4	11.5
16	9.5	13.2

-SPT

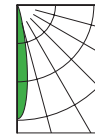

Lm: 1744
SC: 0.3

-NFL

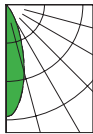

Lm: 1553
SC: 0.6

-WFL

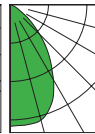

Lm: 1514
SC: 1.1

LSR-06473-1500L
LSR-06473-1000L

Pendant and Wall Bracket Mounts Optional

Downlights

9"

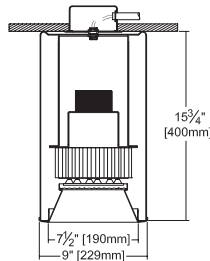

5739 LUMENS

72.7W

MFL (STD)

SC: 0.7

LPW: 79

-6500L SERIES PERFORMANCE

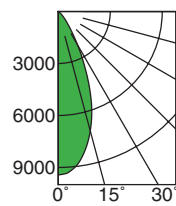

Cone of Light ▲

Dist.	FC	Dia.
6	262.1	4.3
8	147.4	5.8
10	94.4	7.2
12	65.5	8.6
14	48.1	10.1
16	36.9	11.5

-SPT

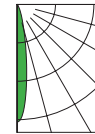

Lm: 6321
SC: 0.3

-WFL

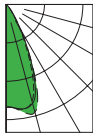

Lm: 6100
SC: 0.9

LSR-09479-6500L
LSR-09479-5000L
LSR-09479-3500L
LSR-09479-2500L

Pendant and Wall Bracket Mounts Optional

9"

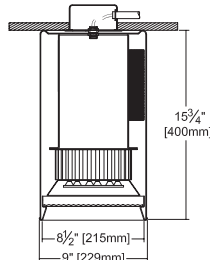

5610 LUMENS

74.2W

WFL

SC: 1.0

LPW: 76

-6500L SERIES PERFORMANCE

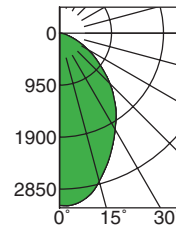

Cone of Light ▲

Dist.	FC	Dia.
6	87.4	6.0
8	49.2	8.0
10	31.5	10.0
12	21.9	12.0
14	16.1	14.0
16	12.3	16.0

▲ Cone of Light Key

Dist. Distance from fixture
FC Footcandles at nadir (0°)
Dia. Circle of light at 50% of FC

Dia. (in ft.) shown is where FC value is half the FC at nadir.

LSR-09480-6500L
LSR-09480-5000L
LSR-09480-3500L
LSR-09480-2500L

Pendant and Wall Bracket Mounts Optional

See Options on page 28

12"

Downlights

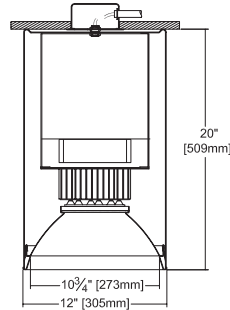

- LSR-12481-6500L
- LSR-12481-5000L
- LSR-12481-3500L
- LSR-12481-2500L

-6500L SERIES PERFORMANCE

6094 LUMENS

73.7W

MFL (STD)

SC: 0.8

LPW: 83

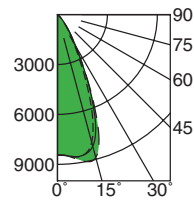

Cone of Light ▲

Dist.	FC	Dia.
6	234.4	5.0
8	131.8	6.6
10	84.4	8.3
12	59.6	9.9
14	43.0	11.6
16	33.0	13.2

-SPT

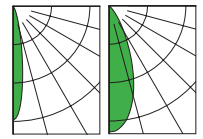

Lm: 6314
SC: 0.3

-NFL

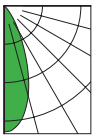

Lm: 5834
SC: 0.7

Pendant and Wall Bracket Mounts Optional

12"

Adjustable

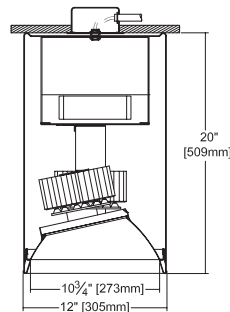

- LSR-12482-6500L
- LSR-12482-5000L
- LSR-12482-3500L
- LSR-12482-2500L

-6500L SERIES PERFORMANCE

5620 LUMENS

74.0W

NFL (STD)

SC: 0.6

LPW: 76

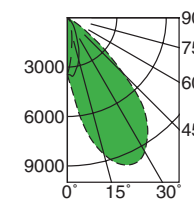

-SPT

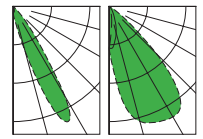

Lm: 6140
SC: 0.3

-NFL

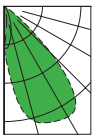

Lm: 6040
SC: 0.8

Pendant and Wall Bracket Mounts Optional

12"

Downlights

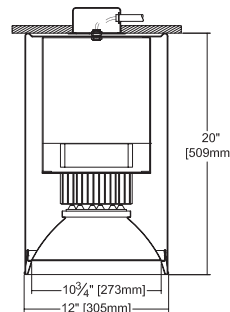

- LSR-12483-6500L
- LSR-12483-5000L
- LSR-12483-3500L
- LSR-12483-2500L

-6500L SERIES PERFORMANCE

5630 LUMENS

73.6W

WFL

SC: 0.9

LPW: 77

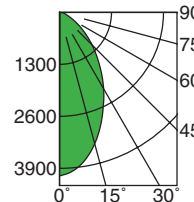

Cone of Light ▲

Dist.	FC	Dia.
6	113.6	5.3
8	63.9	7.1
10	40.9	8.9
12	28.4	10.7
14	20.9	12.4
16	16.0	14.2

▲ Cone of Light Key

- Dist. Distance from fixture
- FC Footcandles at nadir (0°)
- Dia. Circle of light at 50% of FC

Dia. (in ft.) shown is where FC value is half the FC at nadir.

Pendant and Wall Bracket Mounts Optional

See Options on page 28

Super Shallow Downlights

12"

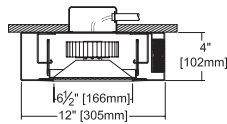

LSR-12484-2000L
LSR-12484-1500L
LSR-12484-1000L

1600 LUMENS

19.1W

WFL

SC: 1.2

LPW: 84

-1500L SERIES PERFORMANCE

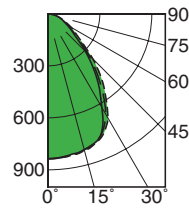

Cone of Light ▲

Dist.	FC	Dia.
6	23.2	7.1
8	13.1	9.4
10	8.4	11.8
12	5.8	14.1
14	4.3	16.5
16	3.3	18.8

Super Shallow Vandal

12"

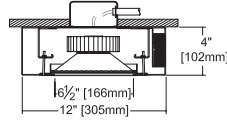

LSV-12487-2000L
LSV-12487-1500L
LSV-12487-1000L

1429 LUMENS

20.9W

WFL

SC: 1.2

LPW: 68

-1500L SERIES PERFORMANCE

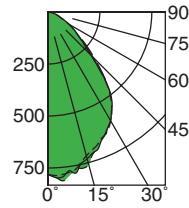

Cone of Light ▲

Dist.	FC	Dia.
6	21.7	6.9
8	12.2	9.2
10	7.8	11.5
12	5.4	13.9
14	4.0	16.2
16	3.1	18.5

Super Shallow Vandal

12"

NEW!

NOW WITH SUPER SHALLOW 4" HOUSING!

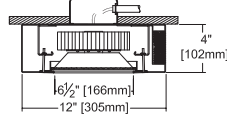

LSV-12488-2500L

2814 LUMENS

35.1W

WFL

SC: 0.9

LPW: 80

-2500L SERIES PERFORMANCE

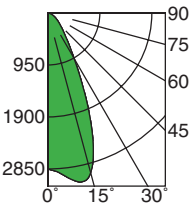

Cone of Light ▲

Dist.	FC	Dia.
6	79.2	5.2
8	44.5	6.9
10	28.5	8.6
12	19.8	10.3
14	14.5	12.0
16	11.1	13.8

▲ Cone of Light Key
Dist. Distance from fixture
FC Footcandles at nadir (0°)
Dia. Circle of light at 50% of FC
 Dia. (in ft.) shown is where FC value is half the FC at nadir.

Direct / Indirect*

3"

NEW!

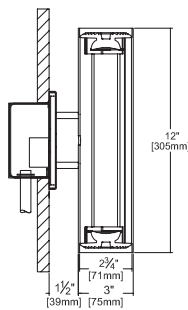

LWR-03489-1500L

DIRECT/INDIRECT

1420/1420 LUMENS

37.0W†

MFL

SC: 0.8

LPW: 77

-1500L SERIES PERFORMANCE

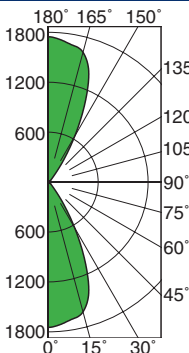

Cone of Light ▲

Dist.	FC	Dia.
6	48.5	5.3
8	27.3	7.1
10	17.5	8.8
12	12.1	10.6
14	8.9	12.4
16	6.8	14.1

-SPT



Lm: 1397
 SC: 0.3

-NFL



Lm: 1413
 SC: 0.4

†Total system watts shown

* Direct / Indirect product number displays downlight position lumens.

See Options on page 28

9"

Flagpole

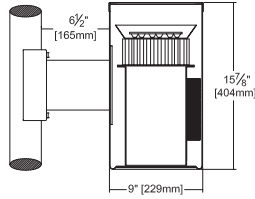

5909 LUMENS

73.8W

SPT

SC: 0.3

LPW: 80

-6500L SERIES PERFORMANCE

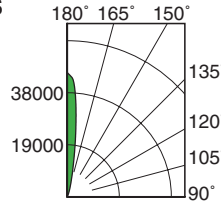

- LWR-09490-6500L
- LWR-09490-5000L
- LWR-09490-3500L

6"

NEW!

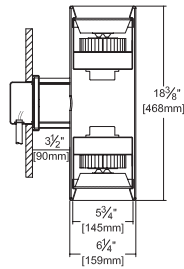

DIRECT/INDIRECT

1720/1720 LUMENS

41.6W[†]

MFL

SC: 0.8

LPW: 83

-1500L SERIES PERFORMANCE

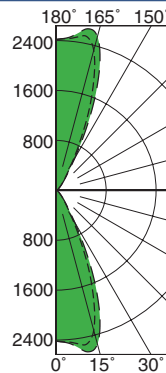

Cone of Light ▲

Dist.	FC	Dia.
6	67.3	4.9
8	37.8	6.6
10	24.2	8.2
12	16.8	9.9
14	12.4	11.5
16	9.5	13.2

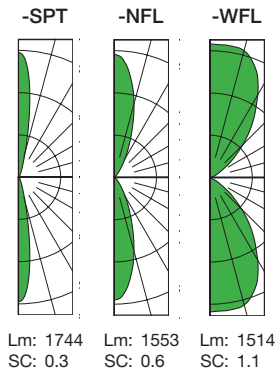

- LWR-06491-2000L
- LWR-06491-1500L
- LWR-06491-1000L

[†]Total system watts shown

9"

Direct / Indirects*

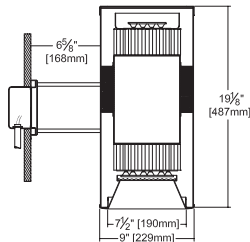

DIRECT/INDIRECT

3940/3001 LUMENS

76.9W[†]

MFL

SC: 0.7

LPW: 90

-3500L SERIES PERFORMANCE

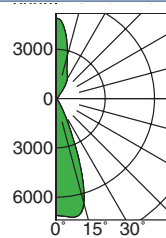

Cone of Light ▲

Dist.	FC	Dia.
6	197.0	4.4
8	111.0	5.8
10	71.0	7.3
12	49.3	8.8
14	36.2	10.2
16	27.7	11.7

- LWR-09492-3500L
- LWR-09492-2500L

[†]Total system watts shown

9"

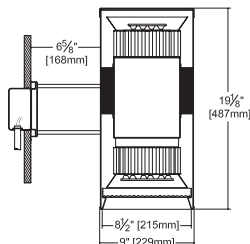

DIRECT/INDIRECT

3676/2846 LUMENS

79.0W[†]

WFL

SC: 1.0

LPW: 83

-3500L SERIES PERFORMANCE

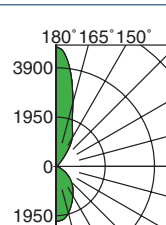

Cone of Light ▲

Dist.	FC	Dia.
6	60.2	5.8
8	33.9	7.8
10	21.7	9.7
12	15.0	11.6
14	11.1	13.6
16	8.5	15.5

▲ Cone of Light Key
 Dist. Distance from fixture
 FC Footcandles at nadir (0°)
 Dia. Circle of light at 50% of FC
 Dia. (in ft.) shown is where FC value is half the FC at nadir.

- LWR-09496-3500L
- LWR-09496-2500L

[†]Total system watts shown

* Direct / Indirect product number displays downlight position lumens.

See Options on page 28

4"

Downlights

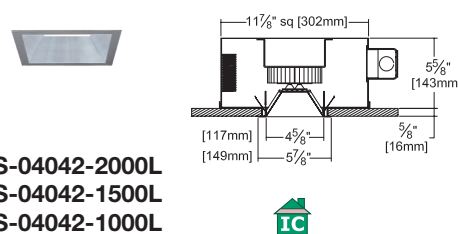

LRS-04042-2000L
LRS-04042-1500L
LRS-04042-1000L

1579 LUMENS
21.1W
MFL (STD)
SC: 0.8
LPW: 75

-1500L SERIES PERFORMANCE

Cone of Light ▲

Dist.	FC	Dia.
6	72.6	4.6
8	40.8	6.1
10	26.1	7.7
12	18.1	9.2
14	13.3	10.7
16	10.2	12.3

-SPT **-NFL**

Lm: 1704 SC: 0.3 Lm: 1434 SC: 0.6

4"

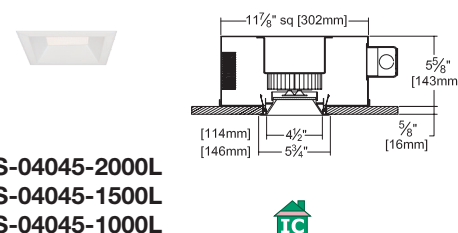

LRS-04045-2000L
LRS-04045-1500L
LRS-04045-1000L

1606 LUMENS
21.2W
MFL (STD)
SC: 0.8
LPW: 76

-1500L SERIES PERFORMANCE

Cone of Light ▲

Dist.	FC	Dia.
6	67.8	4.7
8	38.1	6.3
10	24.4	7.8
12	16.9	9.4
14	12.4	11.0
16	9.5	12.5

-NFL

Lm: 1589 SC: 0.5

4"

Super Shallow

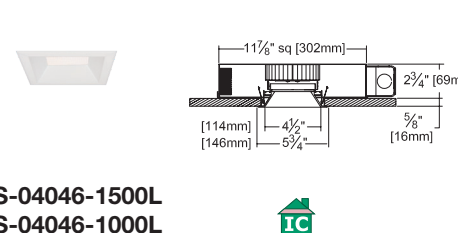

LRS-04046-1500L
LRS-04046-1000L

1606 LUMENS
21.2W
MFL (STD)
SC: 0.8
LPW: 76

-1500L SERIES PERFORMANCE

Cone of Light ▲

Dist.	FC	Dia.
6	67.8	4.7
8	38.1	6.3
10	24.4	7.8
12	16.9	9.4
14	12.4	11.0
16	9.5	12.5

-NFL

Lm: 1589 SC: 0.5

2"

Downlight

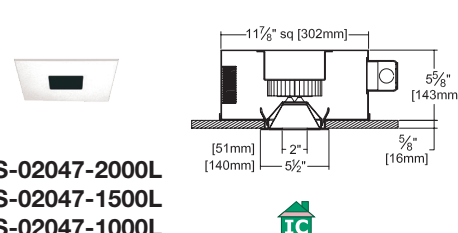

LRS-02047-2000L
LRS-02047-1500L
LRS-02047-1000L

1380 LUMENS
20.8W
SC: 0.4
LPW: 66

-1500L SERIES PERFORMANCE

Cone of Light ▲

Dist.	FC	Dia.
6	285.7	2.1
8	160.7	2.8
10	102.9	3.5
12	71.4	4.1
14	52.5	4.8
16	40.2	5.5

4"

Adjustables

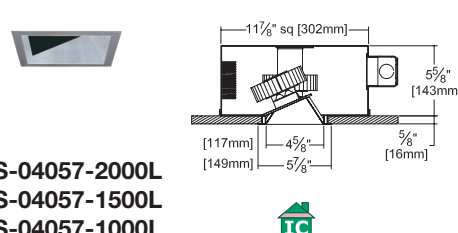

LRS-04057-2000L
LRS-04057-1500L
LRS-04057-1000L

1415 LUMENS
20.8W
NFL (STD)
SC: 0.6
LPW: 68

-1500L SERIES PERFORMANCE

-SPT **-MFL**

Lm: 1603 SC: 0.3 Lm: 1590 SC: 0.9

2"

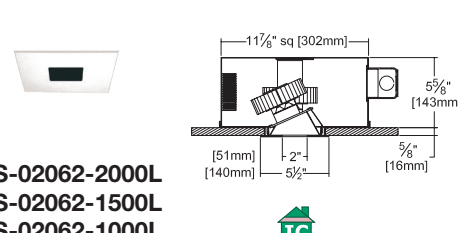

LRS-02062-2000L
LRS-02062-1500L
LRS-02062-1000L

1283 LUMENS
21.0W
SC: 0.4
LPW: 61

-1500L SERIES PERFORMANCE

▲ Cone of Light Key
Dist. Distance from fixture
FC Footcandles at nadir (0°)
Dia. Circle of light at 50% of FC

Dia. (in ft.) shown is where FC value is half the FC at nadir.

4"

-1500L SERIES PERFORMANCE

Wall Wash

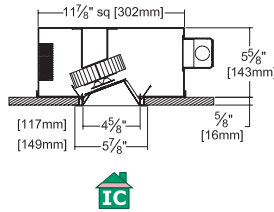

1385 LUMENS
20.9W
 LPW: 66

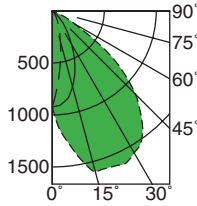

▲ Cone of Light Key
 Dist. Distance from fixture
 FC Footcandles at nadir (0°)
 Dia. Circle of light at 50% of FC
 Dia. (in ft.) shown is where FC value is half the FC at nadir.

LRS-04072-2000L
 LRS-04072-1500L
 LRS-04072-1000L



6"

NEW!

-1500L SERIES PERFORMANCE

Downlight

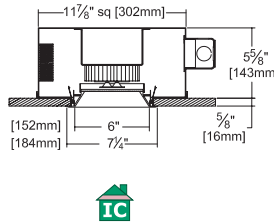

1606 LUMENS
21.2W
MFL (STD)
 SC: 0.8
 LPW: 76

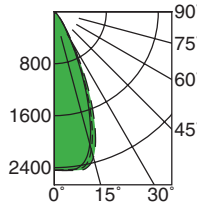

Cone of Light ▲

Dist.	FC	Dia.
6	67.8	4.7
8	38.1	6.3
10	24.4	7.8
12	16.9	9.4
14	12.4	11.0
16	9.5	12.5

-NFL

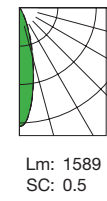

LRS-06085-2000L
 LRS-06085-1500L
 LRS-06085-1000L



4"

-2500L SERIES PERFORMANCE

Shallow Downlights

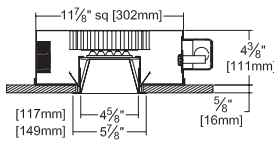

2944 LUMENS
36.6W
MFL (STD)
 SC: 0.7
 LPW: 80

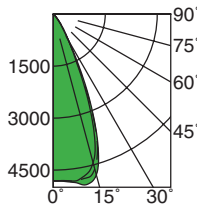

Cone of Light ▲

Dist.	FC	Dia.
6	134.0	4.7
8	75.2	6.3
10	48.1	7.8
12	33.4	9.4
14	24.5	10.9
16	18.8	12.5

-SPT

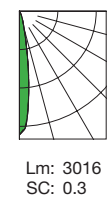

-NFL

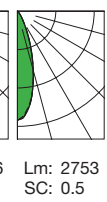

LRS-04500-2500L

4"

-2500L SERIES PERFORMANCE

Shallow Downlights

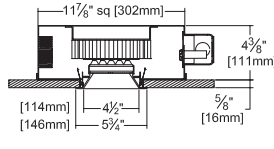

2277 LUMENS
36.3W
MFL (STD)
 SC: 0.8
 LPW: 63

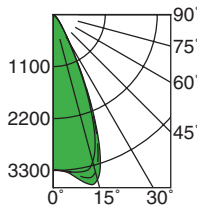

Cone of Light ▲

Dist.	FC	Dia.
6	91.1	4.9
8	51.2	6.5
10	32.8	8.2
12	22.8	9.8
14	16.7	11.4
16	12.8	13.0

-NFL

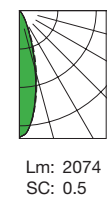

LRS-04503-2500L

6"

-6500L SERIES PERFORMANCE

Downlights

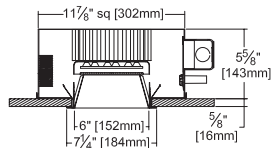

6086 LUMENS
73.3W
MFL (STD)
 SC: 0.7
 LPW: 73

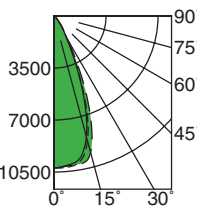

Cone of Light ▲

Dist.	FC	Dia.
6	284.3	4.5
8	159.9	6.0
10	102.4	7.5
12	71.1	9.0
14	52.2	10.5
16	40.0	12.0

-SPT

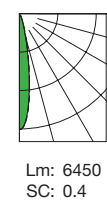

-WFL

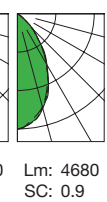

LRS-06505-6500L
 LRS-06505-5000L
 LRS-06505-3500L
 LRS-06505-2500L

6"

NEW!

-2500L SERIES PERFORMANCE

Downlights

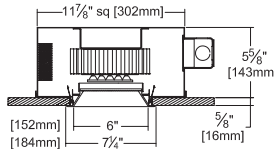

3085 LUMENS
32.4W
MFL (STD)
 SC: 0.8
 LPW: 95

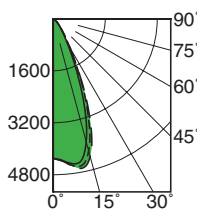

Cone of Light ▲

Dist.	FC	Dia.
6	119.3	4.8
8	67.1	6.4
10	43.0	8.0
12	29.8	9.6
14	21.9	11.2
16	16.8	12.8

LRS-06507-2500L

Adjustables

4"

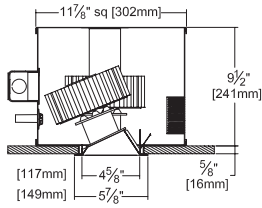

2061 LUMENS

35.1W
NFL (STD)
SC: 0.6
LPW: 59

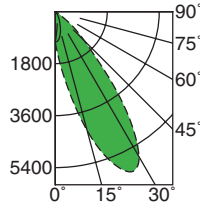

-2500L SERIES PERFORMANCE

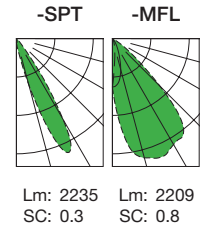

LRS-04508-2500L

6"

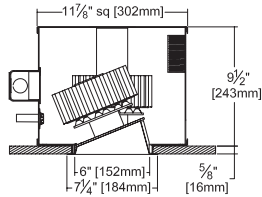

5457 LUMENS

73.2W
NFL (STD)
SC: 0.6
LPW: 75

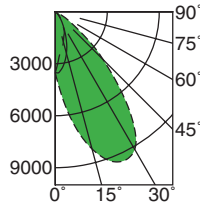

-6500L SERIES PERFORMANCE

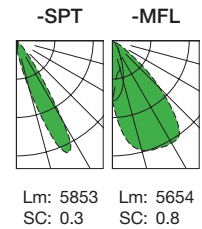

LRS-06510-6500L
LRS-06510-5000L
LRS-06510-3500L
LRS-06510-2500L

Wall Washes

4"

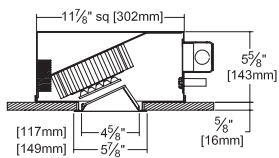

2896 LUMENS

36.8W
LPW: 79

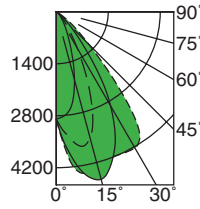

-2500L SERIES PERFORMANCE

LRS-04515-2500L

6"

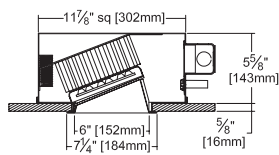

5538 LUMENS

73.3W
LPW: 76

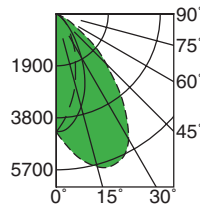

-6500L SERIES PERFORMANCE

LRS-06520-6500L
LRS-06520-5000L
LRS-06520-3500L
LRS-06520-2500L

See Options on page 28

8"

Shallow "K" Lens Downlights

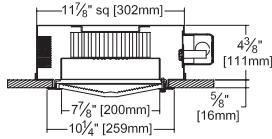

2693 LUMENS
35.4W
WFL
 SC: 1.2
 LPW: 76

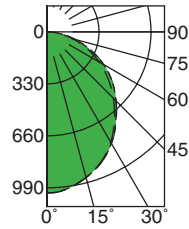

Cone of Light ▲

Dist.	FC	Dia.
6	28.4	7.1
8	16.0	9.5
10	10.2	11.9
12	7.1	14.3
14	5.2	16.6
16	4.0	19.0

LRS-08525-2500L

10"

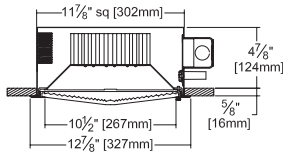

4725 LUMENS
57.5W
WFL
 SC: 1.3
 LPW: 82

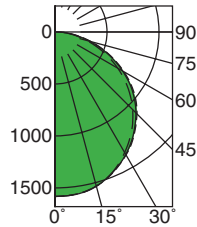

Cone of Light ▲

Dist.	FC	Dia.
6	43.9	7.6
8	24.7	10.2
10	15.8	12.7
12	11.0	15.3
14	8.1	17.8
16	6.2	20.4

LRS-10526-5000L
LRS-10526-3500L

8"

Downlights

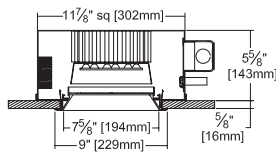

5987 LUMENS
73.3W
MFL (STD)
 SC: 0.8
 LPW: 82

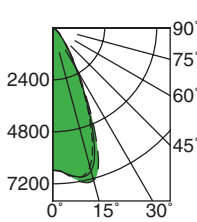

Cone of Light ▲

Dist.	FC	Dia.
6	182.6	5.3
8	102.7	7.0
10	65.7	8.8
12	45.6	10.5
14	33.5	12.3
16	25.7	14.0

-NFL



-WFL

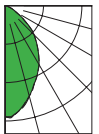

Lm: 6050 SC: 0.5
 Lm: 5248 SC: 1.0

LRS-08530-6500L
LRS-08530-5000L
LRS-08530-3500L
LRS-08530-2500L

11"

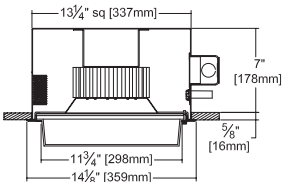

6501 LUMENS
74.0W
WFL
 SC 0°: 2.0
 SC 90°: 1.1
 LPW: 88

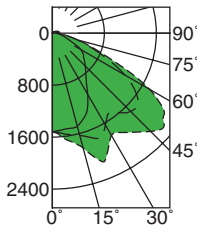

Cone of Light ▲

Dist.	FC	Dia.
6	42.1	9.1
8	23.7	12.2
10	15.2	15.2
12	10.5	18.3
14	7.7	21.3
16	5.9	24.4

▲ Cone of Light Key
Dist. Distance from fixture
FC Footcandles at nadir (0°)
Dia. Circle of light at 50% of FC
 Dia. (in ft.) shown is where FC value is half the FC at nadir.

LRS-11535-6500L

See Options on page 28

7"

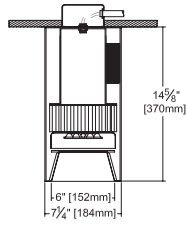

LSS-07540-2500L

-2500L SERIES PERFORMANCE

2932 LUMENS

36.7W
MFL (STD)
SC: 0.8
LPW: 80

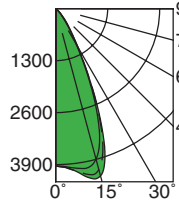

Cone of Light ▲

Dist.	FC	Dia.
6	109.0	5.1
8	61.5	6.8
10	39.4	8.5
12	27.3	10.2
14	20.1	11.9
16	15.4	13.6

-SPT -NFL

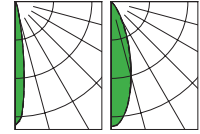

Lm: 3028 SC: 0.3
Lm: 2932 SC: 0.6

7"

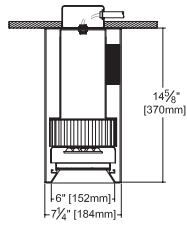

LSS-07545-2500L

-2500L SERIES PERFORMANCE

2304 LUMENS

34.7W
WFL
SC: 0.9
LPW: 66

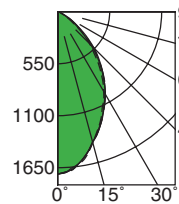

Cone of Light ▲

Dist.	FC	Dia.
6	47.7	5.6
8	26.8	7.4
10	17.2	9.3
12	11.9	11.1
14	8.8	13.0
16	6.7	14.8



Lm: 6450 SC: 0.4
Lm: 4680 SC: 0.9

Downlights

7"

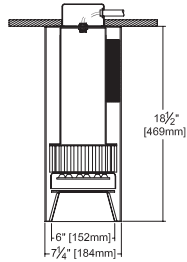

LSS-07550-6500L

LSS-07550-5000L

LSS-07550-3500L

-6500L SERIES PERFORMANCE

6086 LUMENS

73.3W
MFL (STD)
SC: 0.7
LPW: 83

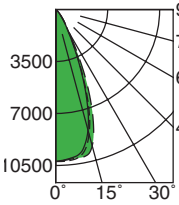

Cone of Light ▲

Dist.	FC	Dia.
6	284.3	4.5
8	159.9	6.0
10	102.4	7.5
12	71.1	9.0
14	52.2	10.5
16	40.0	12.0

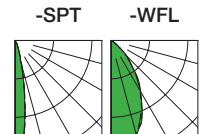

Lm: 4497 SC: 0.9

7"

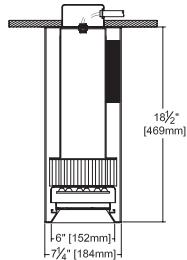

LSS-07555-5000L

LSS-07555-3500L

-5000L SERIES PERFORMANCE

4497 LUMENS

57.6W
WFL
SC: 0.9
LPW: 78

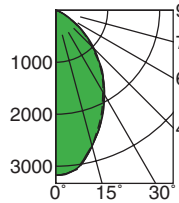

Cone of Light ▲

Dist.	FC	Dia.
6	88.2	5.6
8	49.6	7.5
10	31.8	9.4
12	22.1	11.2
14	16.2	13.1
16	12.4	15.0



Lm: 6450 SC: 0.4
Lm: 4680 SC: 0.9

▲ Cone of Light Key

Dist. Distance from fixture
FC Footcandles at nadir (0°)
Dia. Circle of light at 50% of FC

Dia. (in ft.) shown is where FC value is half the FC at nadir.

See Options on page 28

13"

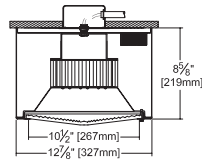

LSS-13560-6500L
LSS-13560-5000L
LSS-13560-3500L

-6500L SERIES PERFORMANCE

5795 LUMENS

74.0W

WFL

SC: 1.3

LPW: 78

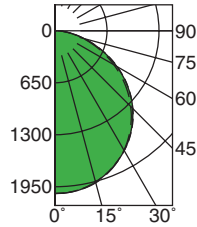

Cone of Light ▲

Dist.	FC	Dia.
6	56.5	7.6
8	31.8	10.1
10	20.3	12.6
12	14.1	15.1
14	10.4	17.7
16	7.9	20.2

13"

Downlights

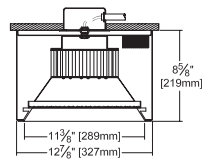

LSS-13565-6500L
LSS-13565-5000L
LSS-13565-3500L

-6500L SERIES PERFORMANCE

5795 LUMENS

73.6W

WFL

SC: 1.4

LPW: 81

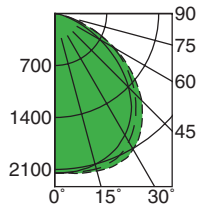

Cone of Light ▲

Dist.	FC	Dia.
6	59.7	8.1
8	33.6	10.9
10	21.5	13.6
12	14.9	16.3
14	11.0	19.0
16	8.4	21.7

14"

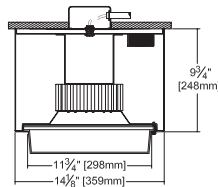

LSS-14570-6500L

-6500L SERIES PERFORMANCE

6501 LUMENS

74.0W

WFL

SC 0°: 2.0
SC 90°: 1.1

LPW: 88

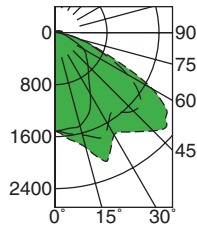

Cone of Light ▲

Dist.	FC	Dia.
6	42.1	9.1
8	23.7	12.2
10	15.2	15.2
12	10.5	18.3
14	7.7	21.3
16	5.9	24.4

7"

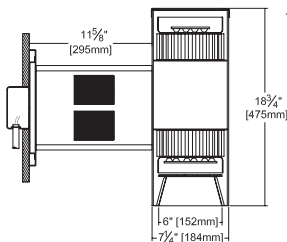

LWS-07575-3500L
LWS-07575-2500L

DIRECT/INDIRECT

3969/3047 LUMENS

77.6W†

MFL

SC: 0.8

LPW: 90

-3500L SERIES PERFORMANCE

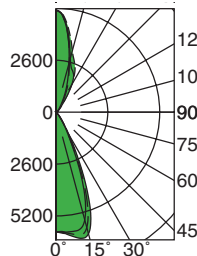

Cone of Light ▲

Dist.	FC	Dia.
6	166.0	4.9
8	93.6	6.5
10	59.9	8.1
12	41.6	9.8
14	30.6	11.4
16	23.4	13.0

†Total system watts shown

7"

Direct / Indirects*

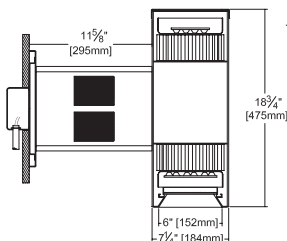

LWS-07580-3500L
LWS-07580-2500L

DIRECT/INDIRECT

3534/3073 LUMENS

77.1W†

WFL

SC: 0.9

LPW: 86

-3500L SERIES PERFORMANCE

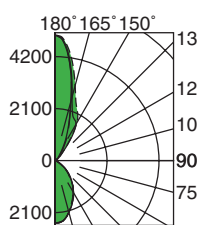

Cone of Light ▲

Dist.	FC	Dia.
6	69.9	5.6
8	39.3	7.5
10	25.2	9.4
12	17.5	11.3
14	12.8	13.2
16	9.8	15.0

†Total system watts shown

* Direct / Indirect product number displays downlight position lumens.

See Options on page 28

Lumen Package: MUST SPECIFY

- 6500L Nominal 6500 lumens (74W)
- 5000L Nominal 5000 lumens (55W)
- 3500L Nominal 3500 lumens (42W)
- 2500L Nominal 2500 lumens (35W)
- 2000L Nominal 2000 lumens (25W)
- 1500L Nominal 1500 lumens (15W)
- 1000L Nominal 1000 lumens (11W)

Options - Discrete Diode Designs

See specification sheets at www.kirlinlighting.com for option availability and details.

Input Power: SPECIFY

- 120 120V (50-60Hz) input (and thermal protector).
- 277 277V (50-60Hz) input (and thermal protector).
- 97 Specify other voltage. Consult factory.

LED Power Supply

- 29 Two wire full range (100-1%) PWM dimming instead (Lutron). 120V only.
- 97 Specify other voltage. Consult factory.
- D1 0-10V 100-1.0% dimming instead.
- D2 0-10V 100-0.1% dimming instead.
- D3 DALI 100-1.0% dimming instead.
- D4 DALI 100-0.1% dimming instead.
- D5 DMX512A 100-0% dimming instead. Consult factory for -6500L lumen series.
- D6 Triac dimming instead. Consult factory.
- ECO Digital driver for Lutron EcoSystem controls.
- EI Remote emergency inverter for 100% of rated lumens for -1500L; 50% for -3500L or -5000L; 40% for -6500L. Run time: 90+ minutes. 120 or 277V, 60 Hz input only. Specify voltage. Not for use with -29 or -FS.
- EM Internal emergency battery pack. Delivers 500 lumens. Run time: 90+ minutes.
- ERH Remote emergency battery pack. Delivers 1000 lumens. Run time: 90+ minutes. CEC Compliant.

LED Color (CCT and CRI)

- 27K 2700°K color temperature instead.
- 30K 3000°K color temperature instead.
- 41K 4100°K color temperature instead.
- 50K 5000°K color temperature instead.
- HC 90+ CRI instead. Consult factory.

Optics

- SPT Spot distribution.
- NFL Narrow flood distribution.
- MFL Medium flood distribution.
- WFL Wide flood distribution.

Lenses and Trims

- 13 Clear poly lens below standard lens.
- 23 Frosted microprismatic lens instead.
- 25 Vandal resistant trim, hardware and lensing.
- 26 Tamper resistant recessed hex screw with center pin. 1 key / 10 fixtures.
- 30 All white acrylic enameled cone.
- 31 White acrylic enameled cone flange.
- 32 White oversize trim ring. Specify O.D.
- 33 Decorative Glow Ring suspended trim.
- 35F Silver (natural aluminum) cone flange.
- 37F Dark bronze acrylic enameled cone flange.
- 38F Black acrylic enameled cone flange.
- 35T Silver (natural aluminum) enameled trim.
- 37T Dark bronze acrylic enameled trim.
- 38T Black acrylic enameled trim.
- 45 Gasket between trim flange and ceiling.
- 46 Gasket between trim and lens.
- 62 Specular clear regressed trim.
- 70 SofTex™ clear self-flanged cone.
- 94 Custom color/finish. Specify. Consult factory.
- BG BioGard™ antimicrobial trim finish (white only).
- CF Custom color filter (Rosco). Specify.
- DA Diffuse acrylic lens above poly instead.
- DF Electrically isolated "dead front" gasketed trim.
- NS NSF approved luminaire.
- WA White acrylic (flat) diffuser instead.

Recessed Housings

- 79 Extension collar for ceilings up to 2" thick.
- AT Air tight version. Meets ASTM E283 restricted airflow of 2 CFM maximum. (for Type IC)

- RH Residential mounting hardware instead. Suitable for wood joist spacings 14 1/8" - 25 7/8".
- SH Sealed housing / CCEA approved. (non IC)

Surface Housing Finishes

- 35 Silver (natural aluminum) acrylic enamel.
- 37 Dark Bronze acrylic enamel.
- 38 Black acrylic enamel.
- 94 Custom color/finish. Specify. Consult factory.

Surface / Pendant / Wall Bracket Mounting

- 80 2" collar for mounting beneath surface outlet box. 1/2" T.S. KO's. Must add Option -89 for wet label listing.
- 87 Custom pendant / wall bracket length. Specify length. Also use with Option -PM or -WB.
- 88 Swivel canopy for sloped ceilings up to 40°. Use with Option -PM.
- 89 Sealed top WeatherCap™ for surface, pendant or wall bracket mounts. Required for wet label.
- CMB Cord pendant mount; black straight cord. 48" standard length or see Option -87.
- PM Pendant mount. 48" stem plus 4" offset. Also see Option -87. Must add Option -89 for wet label listing.
- SM Surface mount instead.
- WB Wall bracket mount. Must add Option -89 For wet label listing. Also see -87.

Other

- 99 Special modification. Consult factory.
- FS Single in-line fuse. Not for use with Option -EI.
- NAT Modified for natatorium use.



Gazelle Express Program

4-3/8" - 5-5/8" Depths

Latitudes Product #	Gazelle Product #	Description	Trim
LRR-04002	GRR-04202	Type IC 4" Round Downlight	
LRR-06003	GRR-06203	Type IC 6" Round Downlight	
LRR-04005	GRR-04205	Type IC 4" Round Lensed Downlight	
LRR-06019	GRR-06219	Type IC 6" Lensed Downlight	
LRR-04102	GRR-04102	Integrated Module 4" Round Downlight	
LRR-06103	GRR-06103	Integrated Module 6" Round Downlight	
LRR-05110	GRR-05110	Integrated Module 6" Dead Front Shower Light	
LRS-04142	GRS-04142	Integrated Module 4" Square Downlight	

Latitudes Catalog to Gazelle Express Catalog Cross Reference Guide

Kirlin Quality Downlights Ship Complete within 5 Business Days!

Orders received by 10:00 AM (Eastern time) ship by 5:00 PM within 5 business days.

Please refer to the latest Gazelle Express Catalog or visit www.kirlinlighting.com for the most current and complete luminaire and Gazelle Express Program information.

KIRLIN Select

Integrated Module Technology (IMT) Offering These Exclusive Benefits:

- Ultra high efficacy integrated compact module: lighthead, driver, heatsink
- 2000, 1500 or 1100 lumen designs
- 1% low end dimming, 0-10V
- Wide flood; fewer fixtures (1.2 SC)
- Color temperature 35K; optional 30K, 41K
- Shallow 4-3/8" depth
- Wet Location, IC Rated Standard
- World voltage 120-277, 50/60 Hz.
- Full 5 year warranty
- 80+ CRI
- White trims, optional SofTex™ or custom colors
- Exceeds 1,000 hour ASTM 5% salt spray test
- Rustproof and corrosion free
- No remote phosphor (eliminates "egg yolk")



4"

NEW!

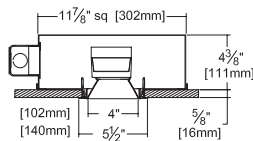

LRR-04102-2000L
LRR-04102-1500L
LRR-04102-1100L



1988 LUMENS

20.3W

WFL

SC: 1.2

LPW: 98

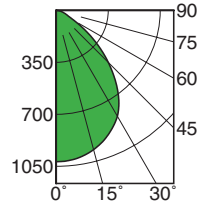

Cone of Light ▲

Dist.	FC	Dia.
6	28.3	7.2
8	15.9	9.6
10	10.2	12.0
12	7.1	14.4
14	5.2	16.8
16	4.0	19.2

KIRLIN
Select

6"

NEW!

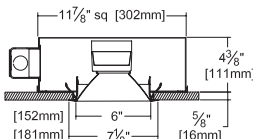

LRR-06103-2000L
LRR-06103-1500L
LRR-06103-1100L



1984 LUMENS

19.9W

WFL

SC: 1.2

LPW: 100

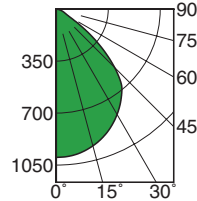

Cone of Light ▲

Dist.	FC	Dia.
6	27.7	7.3
8	15.6	9.8
10	10.0	12.2
12	6.9	14.7
14	5.1	17.1
16	3.9	19.5

Downlight

4"

NEW!

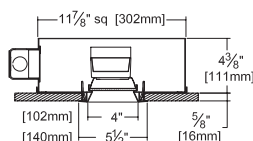

LRR-04105-2000L
LRR-04105-1500L
LRR-04105-1100L



1873 LUMENS

20.1W

WFL

SC: 1.2

LPW: 93

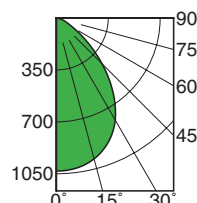

Cone of Light ▲

Dist.	FC	Dia.
6	28.7	6.9
8	16.1	9.2
10	10.3	11.5
12	7.2	13.9
14	5.3	16.2
16	4.0	18.5

▲ Cone of Light Key
Dist. Distance from fixture
FC Footcandles at nadir (0°)
Dia. Circle of light at 50% of FC
Dia. (in ft.) shown is where FC value is half the FC at nadir.

Shower Light

5" **NEW!**



LRR-05110-2000L
LRR-05110-1500L
LRR-05110-1100L

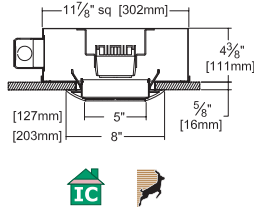

-2000L SERIES PERFORMANCE

1351 LUMENS

20.3W

WFL

SC: 1.2

LPW: 67

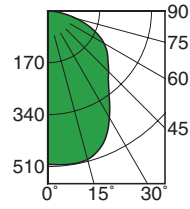

Cone of Light ▲

Dist.	FC	Dia.
6	14.0	7.1
8	7.9	9.5
10	5.0	11.9
12	3.5	14.3
14	2.6	16.7
16	2.0	19.0



IP66 Downlight

6" **NEW!**



LRR-06120-2000L
LRR-06120-1500L
LRR-06120-1100L

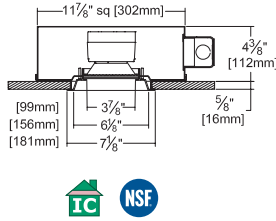

-2000L SERIES PERFORMANCE

1555 LUMENS

20.3W

WFL

SC: 1.1

LPW: 77

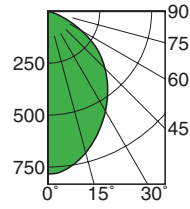

Cone of Light ▲

Dist.	FC	Dia.
6	21.8	6.4
8	12.3	8.6
10	7.8	10.7
12	5.4	12.9
14	4.0	15.0
16	3.1	17.2

Ligature / Vandal

6" **NEW!**



LRV-06121-2000L
LRV-06121-1500L
LRV-06121-1100L

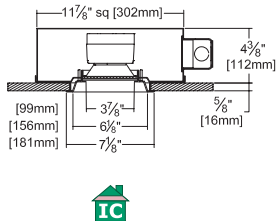

-2000L SERIES PERFORMANCE

1555 LUMENS

20.3W

WFL

SC: 1.1

LPW: 77

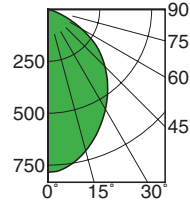

Cone of Light ▲

Dist.	FC	Dia.
6	21.8	6.4
8	12.3	8.6
10	7.8	10.7
12	5.4	12.9
14	4.0	15.0
16	3.1	17.2

Wall Washes

4" **NEW!**



LRR-04137-2000L
LRR-04137-1500L
LRR-04137-1100L

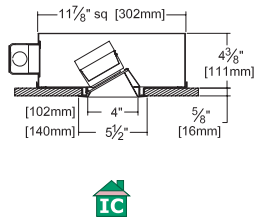

-2000L SERIES PERFORMANCE

1463 LUMENS

20.1W

LPW: 73

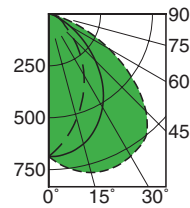

6" **NEW!**



LRR-06139-2000L
LRR-06139-1500L
LRR-06139-1100L

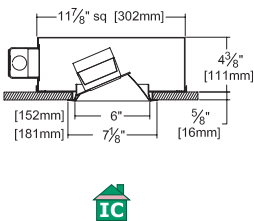

-2000L SERIES PERFORMANCE

2133 LUMENS

20.3W

LPW: 105

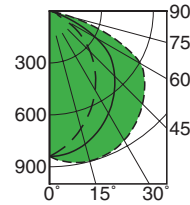

Downlight

4" **NEW!**



LRS-04142-2000L
LRS-04142-1500L
LRS-04142-1100L

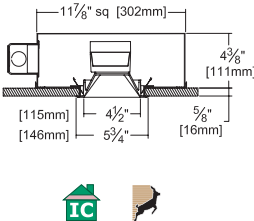

-2000L SERIES PERFORMANCE

2087 LUMENS

20.2W

WFL

SC: 1.2

LPW: 103

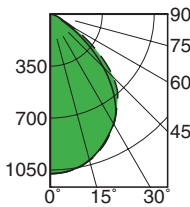

Cone of Light ▲

Dist.	FC	Dia.
6	29.9	7.1
8	16.8	9.5
10	10.8	11.9
12	7.5	14.2
14	5.5	16.6
16	4.2	19.0

▲ Cone of Light Key
Dist. Distance from fixture
FC Footcandles at nadir (0°)
Dia. Circle of light at 50% of FC
Dia. (in ft.) shown is where FC value is half the FC at nadir.

Integrated Module 1100 Lumen (11W) - 2000L (20W)

KIRLIN
Select

6" **NEW!**

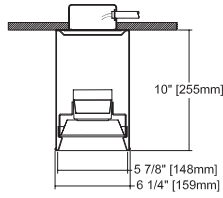

LSR-06173-2000L
LSR-06173-1500L
LSR-06173-1100L

Downlight

-2000L SERIES PERFORMANCE

1629 LUMENS

20.2W

WFL

SC: 1.1

LPW: 81

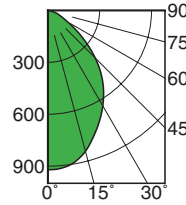

Cone of Light ▲

Dist.	FC	Dia.
6	25.6	6.3
8	14.4	8.5
10	9.2	10.6
12	6.4	12.7
14	4.7	14.8
16	3.6	16.9

KIRLIN
Select

12" **NEW!**

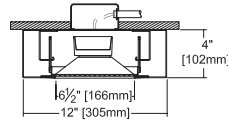

LSR-12184-1500L
LSR-12184-1100L

-1500L SERIES PERFORMANCE

1422 LUMENS

14.8W

WFL

SC: 1.2

LPW: 96

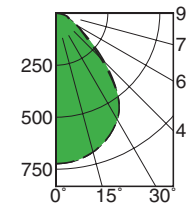

Cone of Light ▲

Dist.	FC	Dia.
6	20.1	7.3
8	11.3	9.7
10	7.2	12.1
12	5.0	14.5
14	3.7	16.9
16	2.8	19.4

6" **NEW!**

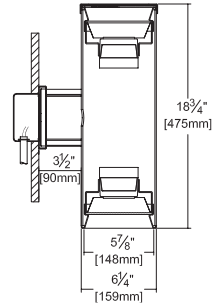

LWR-06191-2000L
LWR-06191-1500L
LWR-06191-1100L

Direct / Indirect*

-2000L SERIES PERFORMANCE

DIRECT/INDIRECT

1633/1167 LUMENS

40.2W†

WFL

SC: 1.1

LPW: 70

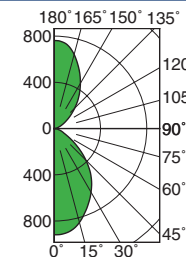

Cone of Light ▲

Dist.	FC	Dia.
6	25.5	6.4
8	14.4	8.5
10	9.2	10.6
12	6.4	12.7
14	4.7	14.8
16	3.6	17.0

▲ **Cone of Light Key**
Dist. Distance from fixture
FC Footcandles at nadir (0°)
Dia. Circle of light at 50% of FC
Dia. (in ft.) shown is where FC value is half the FC at nadir.

† Total system watts shown

* Direct / Indirect product number displays downlight position lumens.

See Options below

KIRLIN *Select* Lumen Packages

Lumen Package:
MUST SPECIFY

-2000L Nominal 2000 lumens (20W)
-1500L Nominal 1500 lumens (15W)
-1100L Nominal 1000 lumens (11W)

KIRLIN *Select* Options

See specification sheets at www.kirlinlighting.com for option availability and details.

LED Power Supply

- 97 Specify other voltage. Consult factory.
- EI Remote emergency inverter for 100% of rated lumens Run time: 90+ minutes. 120 or 277V, 60 Hz input only. Specify voltage. Not for use with -FD or -FS.

LED Color (CCT and CRI)

- 30K 3000°K color temperature instead.
- 41K 4100°K color temperature instead.

Lenses and Trims

- 25 Vandal resistant trim, hardware and lensing.
- 31 White acrylic enameled cone flange.
- 32 White oversize trim ring. Specify O.D.
- 35F Silver (natural aluminum) cone flange.
- 37F Dark bronze acrylic enameled cone flange.
- 38F Black acrylic enameled cone flange.
- 35T Silver (natural aluminum) enameled trim.
- 37T Dark bronze acrylic enameled trim.
- 38T Black acrylic enameled trim.
- 45 Gasket between trim flange and ceiling.

- 70 SoftTex™ clear self-flanged cone.
- 94 Custom color/finish. Specify. Consult factory.
- BG BioGard™ antimicrobial trim finish (white only).
- BN Brushed nickel cast trim instead.
- CF Custom color filter (Rosco). Specify.
- IP IP66 rated trim.
- DA Diffuse acrylic lens above poly instead.
- WA White acrylic (flat) diffuser instead.

Recessed Housings

- 79 Extension collar for ceilings up to 2" thick.
- RH Residential mounting hardware instead. Suitable for wood joist spacings 14 1/8" - 25 7/8".

Surface Housing Finishes

- 35 Silver (natural aluminum) acrylic enamel.
- 37 Dark bronze acrylic enamel.
- 38 Black acrylic enamel.
- 94 Custom color/finish. Specify. Consult factory.

Surface / Pendant / Wall Bracket Mounting

- 54 Safety cable from fixture through pendant stem and 12" beyond. Use with -PM.
- 80 2" collar for mounting beneath surface outlet box. 1/2" T.S. KO's. Must add Option -89 for wet label listing.

- 87 Custom pendant / wall bracket length. Specify length. Also use with Option -PM or -WB.
- 88 Swivel canopy for sloped ceilings up to 40°. Use with Option -PM.
- 89 Sealed top WeatherCap™ for surface, pendant or wall bracket mounts. Required for wet label.
- ASB Aircraft cable pendant mount; black straight cord. 48" or see -87. No wet label listing.
- ASW Aircraft cable pendant mount; white straight cord. 48" or see -87. No wet label listing.
- PM Pendant mount. 48" stem plus 4" offset. Also see Option -87. Must add Option -89 for wet label listing.
- WB Wall bracket mount. Must add Option -89 For wet label listing. Also see -87.

Other

- 84 Wired for two circuits. Also see Option -FD.
- 99 Special modification. Consult factory.
- FD Dual in-line fusing for use with Option -84. Not for use with Option -EI.
- FS Single in-line fuse. Not for use with Option -EI.
- NAT Modified for natatorium use.

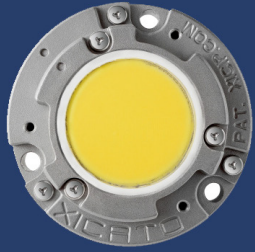

Standard Series

- Functional light with accurate color rendering
- Excellent choice for general lighting
- Color rendering > 82
- Dimming to 1% (standard)
- Lumen packages: -3000L, -2000L, -1300L



San Francisco Museum of Modern Art

XICATO® powered modules from Kirlin are Zhaga compliant COB (chips on board) which provide maximum color mixing with highly aesthetic lighting effects. Experience smooth, high quality illumination, while achieving excellent color consistency and CRI. Standard 3500°K; optional 2700°K, 3000°K or 4000°K. Available dimming technologies: 0-10V, Lutron, DALI, and DMX.

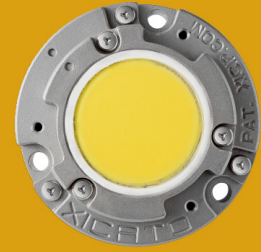

Artist® Series (Option -HC)

- Natural, comfortable light with excellent color rendering
- Great for restaurants, retail and residential
- Halogen quality light
- Color rendering > 95
- Dimming to 1% (standard)
- Lumen packages: -3000L, -2000L, -1300L

XICATO® Recessed Round

4"

Downlight



XRR-04301-3000L
XRR-04301-2000L
XRR-04301-1300L

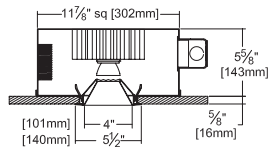

2300 LUMENS

36.8W
MFL
SC: 0.6
LPW: 63

-3000L SERIES PERFORMANCE

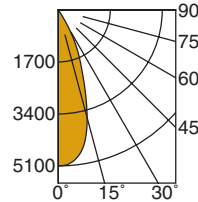

Cone of Light ▲

Dist.	FC	Dia.
6	141.7	3.8
8	79.7	5.1
10	51.0	6.4
12	35.4	7.7
14	26.0	9.0
16	19.9	10.2



Type IC standard -2000L or -1300L lumen series

4"

Adjustable



XRR-04307-3000L
XRR-04307-2000L
XRR-04307-1300L

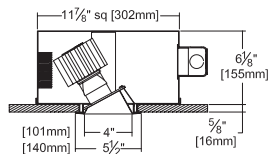

2471 LUMENS

37.0W
MFL
SC: 0.8
LPW: 67

-3000L SERIES PERFORMANCE

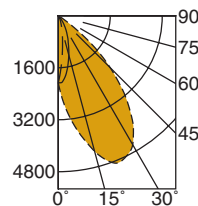

Type IC standard -2000L or -1300L lumen series

4"

Wall Wash



XRR-04311-3000L
XRR-04311-2000L
XRR-04311-1300L

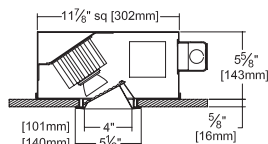

2137 LUMENS

36.6W
LPW: 58

-3000L SERIES PERFORMANCE

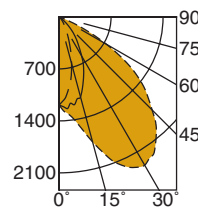

▲ **Cone of Light Key**
Ft. Distance from fixture
FC Footcandles at nadir (0°)
Dia. Circle of light at 50% of FC
Dia. (in ft.) shown is where FC value is half the FC at nadir.



Type IC standard -2000L or -1300L lumen series

XICATO® Recessed Square

4"

Downlight



XRS-04315-3000L
XRS-04315-2000L
XRS-04315-1300L

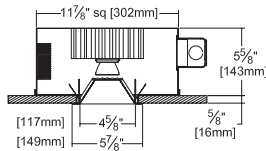

2413 LUMENS

36.8W

MFL

SC: 0.7

LPW: 66

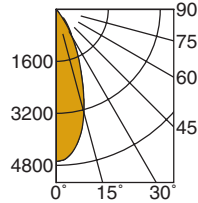

Cone of Light ▲

Dist.	FC	Dia.
6	130.0	3.9
8	73.1	5.2
10	46.8	6.5
12	32.5	7.7
14	23.9	9.0
16	18.3	10.3



Type IC standard -2000L or -1300L lumen series

4"

Adjustable



XRS-04320-3000L
XRS-04320-2000L
XRS-04320-1300L

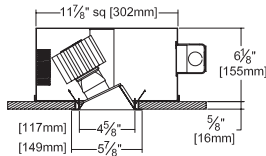

2525 LUMENS

37.0W

MFL

SC: 0.8

LPW: 68

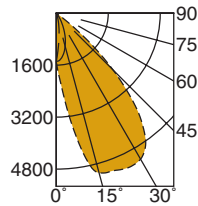

-3000L SERIES PERFORMANCE



Type IC standard -2000L or -1300L lumen series

4"

Wall Wash



XRS-04325-3000L
XRS-04325-2000L
XRS-04325-1300L

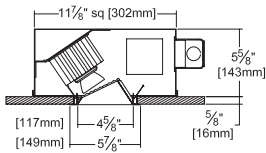

2146 LUMENS

36.6W

LPW: 59

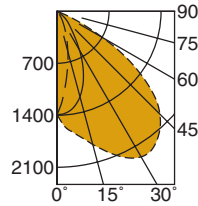

-3000L SERIES PERFORMANCE

▲ Cone of Light Key
Ft. Distance from fixture
FC Footcandles at nadir (0°)
Dia. Circle of light at 50% of FC

Dia. (in ft.) shown is where FC value is half the FC at nadir.



Type IC standard -2000L or -1300L lumen series

XICATO® Lumen Packages

Lumen Package: MUST SPECIFY

- 3000L Nominal 3000 lumens (35W)
- 2000L Nominal 2000 lumens (22W)
- 1300L Nominal 1300 lumens (14W)

XICATO® Options

Input Power: SPECIFY

- 120 120V (50-60Hz) input and thermal protector.
- 277 277V (50-60Hz) input and thermal protector.
- 97 Specify other voltage. Consult factory.

LED Power Supply

- 29 Two wire full range (100-1%) PWM dimming instead (Lutron). 120V only.
- 97 Specify other voltage. Consult factory.
- D2 0-10V 100-0.1% dimming instead.
- D3 DALI 100-1.0% dimming instead.
- D4 DALI 100-0.1% dimming instead.
- D5 DMX512A 100-0% dimming instead.
- ECO Digital driver for Lutron EcoSystem controls.
- EI Remote emergency inverter for 100% of rated lumens. -1300L lumen series only. Run time: 90+ minutes. 120 or 277V, 60 Hz input only. Specify voltage. Not for use with -29 or -FS.
- EM Internal emergency battery pack. Delivers 500 lumens. Run time: 90+ minutes.
- ERH Remote emergency battery pack. Delivers 1000 lumens. Run time: 90+ minutes. CEC Compliant.

LED Color (CCT and CRI)

- 27K 2700°K color temperature instead.
- 30K 3000°K color temperature instead.
- 40K 4000°K color temperature instead.
- HC 95+ CRI Artist® Series instead. 2700°K, 3000°K, 3500°K or 4000°K.

Trim

- 30 All white acrylic enameled cone.
- 31 White acrylic enameled cone flange.
- 32 White oversize trim ring. Specify O.D.
- 33 Decorative Glow Ring suspended trim assembly. Consult factory.
- 37F Dark bronze acrylic enameled cone flange.
- 38F Black acrylic enameled cone flange.
- 37T Dark bronze acrylic enameled trim.
- 38T Black acrylic enameled trim.
- 45 Gasket between trim flange and ceiling.
- 70 SofTex™ clear self-flanged cone.
- 94 Custom color/finish. Specify. Consult factory.
- CF Custom color filter (Rosco). Specify.
- DF Electrically isolated "dead front" gasketed trim.

Other

- 79 Extension collar for ceilings up to 2" thick.
- 99 Special modification. Consult factory.
- AT Air tight version. Meets ASTM E283 restricted airflow of 2 CFM maximum. -2000L or -1300L lumen series only. (for Type IC)
- FS Single in-line fuse. Not for use with Option -EI.
- RH Residential mounting hardware instead. Suitable for wood joist ceilings with spacing from 14 1/8" to 25 7/8" with 5/8" vertical adjustability.
- SH Sealed housing / CCEA approved. -3000L lumen series only. (non IC)

See specification sheets at www.kirlinlighting.com for option availability and details.



LSR-14150



LSS-10155

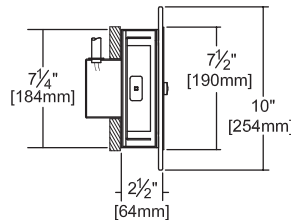
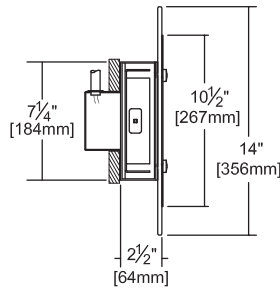

LED Light Engine

- 10 watt LED array
- 3500°K CCT
- 90,000 hours (L70)
- Fully sustainable: Removable for servicing

Sconce Assembly

- Decorative brushed aluminum faceplate with clear 1/4" acrylic diffuser
- Illuminated white center field and edge glow (or specify optional color: see below)
- Overall dimensions
 - Square: 10" square and 2 1/2" deep
 - Round: 14" diameter and 2 1/2" deep

Brushed Anodized Aluminum Housing

- 2 1/2" depth meets all ADA requirements
- All aluminum construction maximizes cool operation and component life
- Optional faceplate and housing finishes

Installation

- Wall or ceiling mount
- Universal back plate mounts to any octagon or 4" square J-box (provided by Kirlin).

Sconce Options



Red Wing
Red
Option -RE



Circadian
Red / Amber
Option -RA



Tiger
Orange
Option -OR



Wolverine
Maize
Option -YE



Spartan
Green
Option -GN



Lion
Blue
Option -BL



Custom
Logo
Option -CL

Single Face	5"		Vandal Resistant Version		3"		UL Wet Listed Optional Vandal Resistant Version		
		LNR-05077*	LNR-05077-26			LNT-03098	LNT-03098-26		
	5"		Vandal Resistant Version		Single Face	7"		UL Wet Listed Optional Vandal Resistant Version	
		LNR-05081*	LNR-05081-26				LNT-07101	LNT-07101-26	
Double Face	5"		Vandal Resistant Version		Double Face	7"		Vandal Resistant Version	
		LNS-05087*	LNS-05087-26				LNT-07102	LNT-07102-26	
Max Security	3"		Vandal Resistant Version		Max Security	7"		Maximum Security Standard	
		LNT-03092	LNT-03092-26				LNV-07126		

StepLights

120V-277V Standard Input Voltage

Single Face	5"		Vandal Resistant Version		Single Face	3"		Vandal Resistant Version	
		LNR-05076*	LNR-05076-26				LNT-03091	LNT-03091-26	
Single Face	5"		Vandal Resistant Version		Single Face	3"		UL Wet Listed Optional Vandal Resistant Version	
		LNS-05086*	LNS-05086-26				LNT-03096	LNT-03096-26	

* Fastener-free face plate available. See Option -FF below.

NightLight & StepLight Options

See specification sheets at www.kirlinlighting.com for option availability and complete details.

Faceplate Finishes

- 35 Natural aluminum (silver) acrylic enamel.
- 37 Dark Bronze acrylic enamel.
- 38 Black acrylic enamel.
- 94 Custom color/finish. Specify. Consult factory.
- BG BioGard™ antimicrobial trim finish (white only).

LED Filter Colors

- BL Blue filter.
- GE Green filter.
- OR Orange filter.
- RA Red/Amber filter. (Circadian)
- YE Yellow filter.
- CF Custom color (Rosco) filter.

Lenses, Trims and Accessories

- 17 High strength acrylic prismatic lens with frame instead of louvers.
- 26 Tamperproof hardware instead. Tool included.
- 34 With hospital grade push button on-off switch.
- GF With hospital grade duplex GFCI (installed).
- G1 With hospital grade duplex GFCI, one side.
- G2 With hospital grade duplex GFCI, both sides.
- HD With hospital grade duplex receptacle (installed). Indoor use.
- H1 With hospital grade duplex receptacle, one side.
- H2 With hospital grade duplex receptacle, both sides.
- L1 .220" clear poly and white acrylic behind diffusion layer instead, one side.
- L2 .220" clear poly and white acrylic behind diffusion layer instead, both sides.

- S1 With hospital grade push button on-off switch, one side.
- S2 With hospital grade push button on-off switch, both sides.

Wattage / Battery Pack

- EI Remote emergency inverter for 100% of rated lumens.
- HW High light output. Approximately doubles light output and system watts.

Other

- 84 Wired for two circuits.
- 99 Special modification. Consult factory.
- FF Fastener free faceplate. No visible hardware.
- PC Photocell. Illuminates NightLight in dark room.
- PC1 Photocell, one side.
- PC2 Photocell, both sides.
- WL UL Wet Location listed.

THE KIRLIN COMPANY

An American Success



1895

Founded in St. Paul, MN. Beauty in lighting accelerated conversion to new technology: electricity.

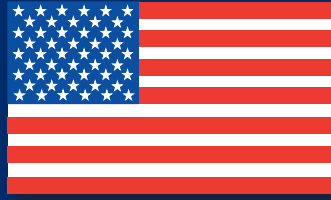

1919

Relocated to Detroit where talent and transportation abounds.



1941

Patented recessed lighting with integral J-box.

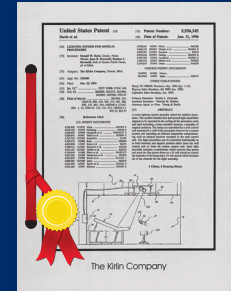

1996

INFRALITE® Motorized Remote Controlled Lighting Systems patented.

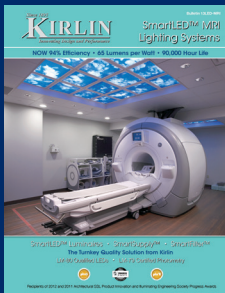

2009

Award winning LED turnkey 3 part lighting system for MRI suites introduced.

2014
LATITUDES Architectural LED Lighting launched. Most comprehensive technology-forward LED collection available.

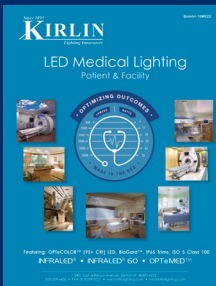
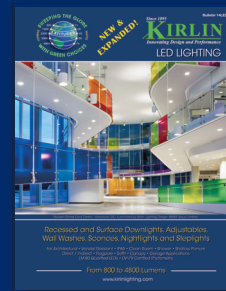

2016

Award winning LED Medical Lighting ~ featuring dual controls for patient procedures and hybrid OR solutions.

2019

Patient-centric, infection controlled, medical lighting collection, featuring: Circadian, color tuning, ligature resistant, color specific, OR, LDRP, ICU/PICU/NICU, IP66, Cleanroom.

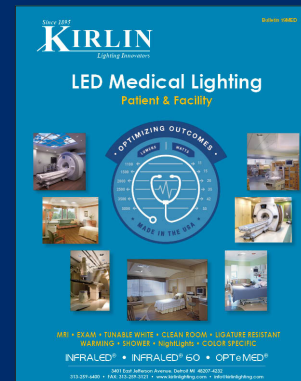

THE KIRLIN COMPANY

3401 East Jefferson Avenue, Detroit MI 48207-4232

313-259-6400 • FAX: 313-259-3121 • www.kirlinlighting.com • info@kirlinlighting.com